

MAHE International

www.maheinternational.com

## Summer/Fall 2006 Specials - Laparoscopy



[1](#) | [2](#) | [3](#) | [4](#) | [5](#) | [6](#)  
 click [here](#) to print to .pdf

**From \$690**







### Standard Modular





#### Bipolar Forceps with Rippled Bar

	220 mm	<a href="#">18.100.20</a>
	250 mm	<a href="#">18.100.25</a>
	340 mm	<a href="#">18.100.34</a>
	450 mm	<a href="#">18.100.45</a>

#### Fine Bipolar Forceps, 1 mm Jaw

	220 mm	<a href="#">18.102.20</a>
	250 mm	<a href="#">18.102.25</a>
	340 mm	<a href="#">18.102.34</a>
	450 mm	<a href="#">18.102.45</a>

#### Bipolar Forceps, 3 mm Jaw

	220 mm	<a href="#">18.104.20</a>
	250 mm	<a href="#">18.104.25</a>
	340 mm	<a href="#">18.104.34</a>
	450 mm	<a href="#">18.104.45</a>

#### Bipolar Forceps, Serrated Jaw

	220 mm	<a href="#">18.106.20</a>
	250 mm	<a href="#">18.106.25</a>
	340 mm	<a href="#">18.106.34</a>
	450 mm	<a href="#">18.106.45</a>

#### Bipolar Scissors, Curved

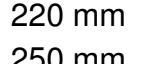
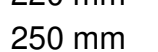
	220 mm	<a href="#">18.108.20</a>
	250 mm	<a href="#">18.108.25</a>

	340 mm	<a href="#"><u>18.108.34</u></a>
	450 mm	<a href="#"><u>18.108.45</u></a>

**Bipolar Maryland, Curved**

	220 mm	<a href="#"><u>18.110.20</u></a>
	250 mm	<a href="#"><u>18.110.25</u></a>
	340 mm	<a href="#"><u>18.110.34</u></a>
	450 mm	<a href="#"><u>18.110.45</u></a>



**Power-Grip (Ring Handle [18.500.05](#))**

>



**Outer Tube**

**Working Length**

200 mm	<a href="#"><u>18.500.20</u></a>
250 mm	<a href="#"><u>18.500.25</u></a>
340 mm	<a href="#"><u>18.500.34</u></a>
450 mm	<a href="#"><u>18.500.45</u></a>

**Bipolar Grasper Micro France**

<b>Length</b>	<b>Insert Only</b>	<b>Complete Instrument</b>
---------------	--------------------	----------------------------

	220 mm	<a href="#"><u>18.501.20</u></a>	<a href="#"><u>18.601.20</u></a>
	250 mm	<a href="#"><u>18.501.25</u></a>	<a href="#"><u>18.601.25</u></a>
	340 mm	<a href="#"><u>18.501.34</u></a>	<a href="#"><u>18.601.34</u></a>
	450 mm	<a href="#"><u>18.501.45</u></a>	<a href="#"><u>18.601.45</u></a>

**Bipolar Grasping Forceps, Delicate Curved**

<b>Length</b>	<b>Insert Only</b>	<b>Complete Instrument</b>
---------------	--------------------	----------------------------

220 mm	<a href="#"><u>18.502.20</u></a>	<a href="#"><u>18.602.20</u></a>
--------	----------------------------------	----------------------------------

	250 mm	<a href="#">18.502.25</a>	<a href="#">18.602.25</a>
	340 mm	<a href="#">18.502.34</a>	<a href="#">18.602.34</a>
	450 mm	<a href="#">18.502.45</a>	<a href="#">18.602.45</a>

**Bipolar Grasping Forceps, Curved**

	<b>Length</b>	<b>Insert Only</b>	<b>Complete Instrument</b>
	220 mm	<a href="#">18.503.20</a>	<a href="#">18.603.20</a>
	250 mm	<a href="#">18.503.25</a>	<a href="#">18.603.25</a>
	340 mm	<a href="#">18.503.34</a>	<a href="#">18.603.34</a>
	450 mm	<a href="#">18.503.45</a>	<a href="#">18.603.45</a>

**Bipolar Grasping Forceps**

	<b>Length</b>	<b>Insert Only</b>	<b>Complete Instrument</b>
	220 mm	<a href="#">18.504.20</a>	<a href="#">18.604.20</a>
	250 mm	<a href="#">18.504.25</a>	<a href="#">18.604.25</a>
	340 mm	<a href="#">18.504.34</a>	<a href="#">18.604.34</a>
	450 mm	<a href="#">18.504.45</a>	<a href="#">18.604.45</a>

**Bipolar Scissors, Curved**

	<b>Length</b>	<b>Insert Only</b>	<b>Complete Instrument</b>
	220 mm	<a href="#">18.505.20</a>	<a href="#">18.605.20</a>
	250 mm	<a href="#">18.505.25</a>	<a href="#">18.605.25</a>
	340 mm	<a href="#">18.505.34</a>	<a href="#">18.605.34</a>
	450 mm	<a href="#">18.505.45</a>	<a href="#">18.605.45</a>

**Bipolar Dissector, Maryland, Curved**

	<b>Length</b>	<b>Insert Only</b>	<b>Complete Instrument</b>
	220		

	mm	<a href="#">18.506.20</a>	<a href="#">18.606.20</a>
	250 mm	<a href="#">18.506.25</a>	<a href="#">18.606.25</a>
	340 mm	<a href="#">18.506.34</a>	<a href="#">18.606.34</a>
	450 mm	<a href="#">18.506.45</a>	<a href="#">18.606.45</a>



**Modular Slimline (Ring Handle [18.800.05](#))**

**Slim Bipolar Forceps with Rippled Bar**

	<b>Length</b>	<b>Insert Only</b>	<b>Complete Instrument</b>
	220 mm	<a href="#">18.700.20</a>	<a href="#">18.701.00</a>
	250 mm	<a href="#">18.700.25</a>	<a href="#">18.701.25</a>
	340 mm	<a href="#">18.700.34</a>	<a href="#">18.701.34</a>
	450 mm	<a href="#">18.700.45</a>	<a href="#">18.701.45</a>

**Slim Bipolar Forceps, with 1 mm Jaw**

	<b>Length</b>	<b>Insert Only</b>	<b>Complete Instrument</b>
	220 mm	<a href="#">18.702.20</a>	<a href="#">18.703.20</a>
	250 mm	<a href="#">18.702.25</a>	<a href="#">18.703.25</a>
	340 mm	<a href="#">18.702.34</a>	<a href="#">18.703.34</a>
	450 mm	<a href="#">18.702.45</a>	<a href="#">18.703.45</a>

[1](#) | [2](#) | [3](#) | [4](#) | [5](#) | [6](#)

**Specials**

**specials**

Thank you for visiting Mahe International.

MAHE International, Inc. • Nashville, TN • Toll Free: 800-294-7946  
© Copyright 2004 MAHE International. All Rights Reserved.