

# 60

## *Sinuscopy*



**MAHE International, Inc.**

**Made in Germany**

**CE / ISO 9001**

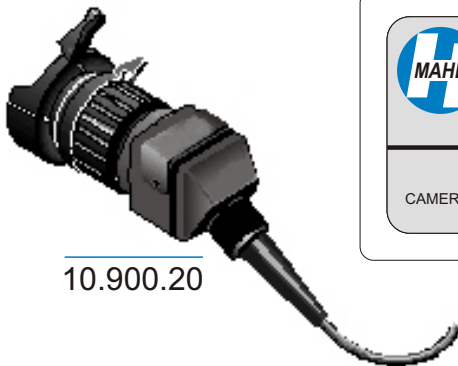

10.900.20

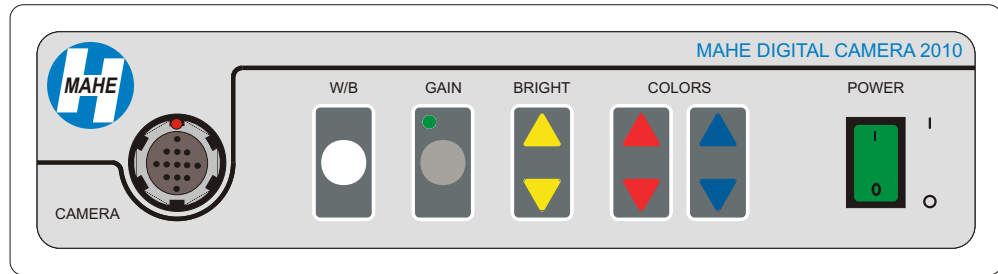

## HIGH RESOLUTION DIGITAL MEDICAL VIDEO CAMERA

**Lightweight compact design and high resolution and sensitivity**

**Variety of camera heads for endoscopy and microscopy**

**Interfaces to all existing rigid and flexible endoscopes**

**Adapters with anti-moiré filters for use with fiberscopes available**

**Fully immersible camera head and optical adapters for endoscopy**

**User-friendly set-up , operation and on-screen Display**

**Automatic white balance and manual color control**

**Automatic electronic shutter for optimal exposure**

**Multiple outputs: composite video, S-VHS and RGB**

**Easy replacement of camera head cable**

### Camera Specifications

<b>Image Device</b>	1/3" CCD Sensor Digital Signal Process
<b>Horizontal Resolution</b>	470 CCD Lines
<b>Number of Pixels</b>	approx. 410,000 pixels 811(H) x 508 (V)
<b>Minimum Illumination</b>	1,5 Lux
<b>White Balance</b>	Automatic by front panel in less than 3 seconds
<b>Signal/ Noise Ratio</b>	Greater than 46dB @ AGC off
<b>Video Outputs</b>	2 x BNC / 1 2 x S-VHS / 1 x RGB
<b>Weight Camera</b>	1.8 kg
<b>Weight Camera Head</b>	46 g
<b>Dimensions</b>	220 (W) x 60 (H) x 250(D) mm



## Fiber Optic Headlights

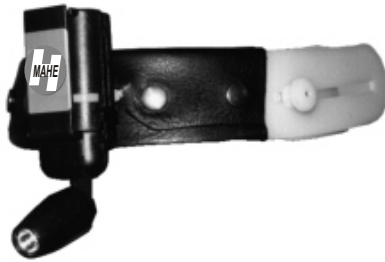

### Xenon Headlight With Integrated Battery Box

Very bright Xenon Headlight with high power optical system and fixed focus. Special miniature Xenon incandescent reflector lamp (6000 candle power), optimized light spot, mobile use with integrated battery box for 2 AA cells. Ergonomic adjustable headband with black leather bolster.

10.081.37 Xenon Headlight With Adjustable Headband & Leather Bolster

10.081.37S Xenon Headlight With Softband

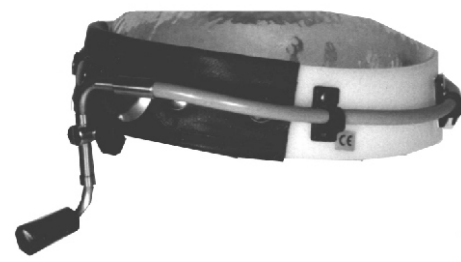

90° Angled

### Office Headlights

High light capacity miniature headlight for intensive depth illumination. Very small adjustable optic. Variable light beam. 2200 mm long F/O light guide is mounted on right side of ergonomic and leather bolstered headband. Without adaptor for light source.

10.083.15 Office Headlight

10.083.17 Office Headlight with Cable End Angled 90 Degrees



90° Angled

### OR Headlights

Operating Room version of miniature headlight. Has a fiber bundle-0 of 3.5 mm as well as a double lense system effect. It has a small and homogenous light spot. The adjustable optic is very small. The variable light beam is 2200 mm long F/O light guide is mounted on the right side of the ergonomic and leather bolstered headband. Without adaptor for the light source.

10.083.25 OR Headlight

10.083.27 OR Headlight with Cable End Angled 90 Degrees

### Economy Miniature OR Headlight With Cross Band

Simple fiber optic miniature headlight for operation theatre. The continuous fiber bundle of 2.6 mm diameter and the small optic produce a small and bright spot light spot. Size and direction of the spot can be adjusted. The ergonomic headband with cross band can be adjusted by one hand and provides comfortable wearing for long periods of use. Without adaptor for light source.

10.083.45 Economy Miniature Headlight With Cross Band

10.083.47 Economy Miniature Headlight with Cross Band & End Angled 90 Degrees



90° Angled

### OR Headlights With Cross Band

Fiber optic miniature headlight for the Operating Room. Perfect view due to the very small optic. The fiber bundle-0 of 3.5 mm. The double lense system effect and a small and homogenous light spot. The leather bolstered headband with the cross band can be adjusted with one hand. The headlight is comfortable during long periods of use. Without adaptor for light source.

10.083.35 OR Headlight With Cross Band

10.083.37 OR Headlight with Cross Band & Cable End Angled 90 Degrees

### Battery Powered Light Sources

#### Xenon Light Handle

11.001.34

2x AAA Batteries



#### System Light Handle

11.001.36

Maximum Light, Minimum Size. Autoclavable. 2 AAA Batteries. Either A Storz, Wolf, or ACMI Adaptor may be ordered separately.



### SIN-He

MAHE International, Inc. 468 Craighead Street Nashville, TN 37204 USA

### SIN-02

Website: [MahelInternational.com](http://MahelInternational.com)

1/2005

Toll Free (800) 294-7946 Phone (615) 269-7256 Fax (615) 269-4605 Email [info@MahelInternational.com](mailto:info@MahelInternational.com)

# Sinuscopes and Accessories

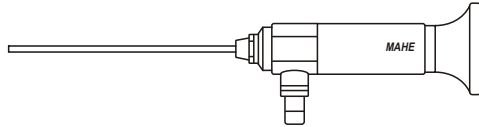

## Mini Sinuscope, Ø 1.7 mm, WL 107 mm

	Non-autoclavable	Autoclavable
0°	60.000.00	60.000.00A

AUTOCLAVE  
134° C / 273° F

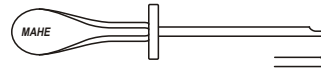

## Trocar and cannula for Sinuscopy

O.D. 5 mm, 8,5 cm cannula length  
bill shaped beak      oblique beak

60.000.10	60.000.15
-----------	-----------

O.D. 3,3 mm, 7,5 cm cannula-length,  
oblique beak, for use with 2,7 mm telescopes

60.000.20



## Telescope Bridge

60.000.25

## Telescope handles



Telescope handle round, 11 cm length  
For forward-oblique and lateral 4 mm telescopes

60.000.01



Telescope handle flat, 11 cm length  
for straight forward 4 mm telescopes

60.000.02

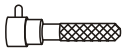

Telescope handle round, 6,5 cm length,  
For 2.7 mm telescopes

60.000.03

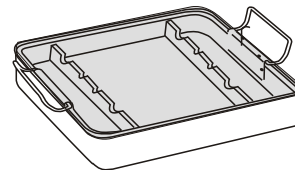

## Endoscope Tray for 2 Sinuscopes

10.014.00

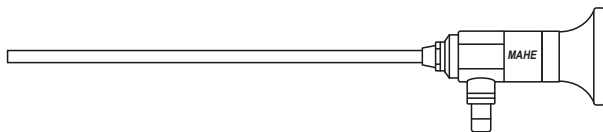

## Sinuscope, Ø 2.7 mm, WL 105 mm

	Non-autoclavable	Autoclavable
0°	60.001.00	60.001.00A
30°	60.001.30	60.001.30A
70°	60.001.70	60.001.70A

AUTOCLAVE  
134° C / 273° F

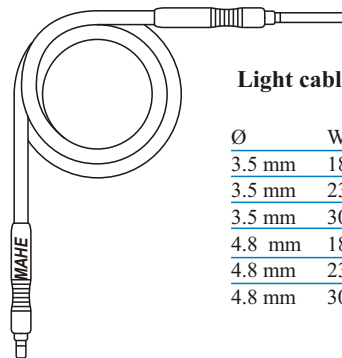

## Light cable

Ø	Working length	
3.5 mm	1800 mm	11.000.00
3.5 mm	2300 mm	11.000.02
3.5 mm	3000 mm	11.000.04
4.8 mm	1800 mm	11.000.06
4.8 mm	2300 mm	11.000.08
4.8 mm	3000 mm	11.000.10

## Sinuscope, Ø 2.7 mm, WL 140 mm

	Non-autoclavable	Autoclavable
0°	60.002.00	60.002.00A
30°	60.002.30	60.002.30A
70°	60.002.70	60.002.70A

## Sinuscope, Ø 2.7 mm, WL 185 mm

	Non-autoclavable	Autoclavable
0°	60.003.00	60.003.00A
30°	60.003.30	60.003.30A
70°	60.003.70	60.003.70A

## Sinuscope, Ø 4 mm, WL 185 mm

	Non-autoclavable	Autoclavable
0°	60.004.00	60.004.00A
30°	60.004.30	60.004.30A
45°	60.004.45	60.004.45A
70°	60.004.70	60.004.70A

## Light Source - Adapter

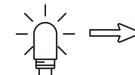

Storz



11.001.00

Olympus



11.001.02

Wolf / Dyonics



11.001.04

ACMI / British Standard

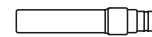

11.001.06

## Endoscope - Adapter

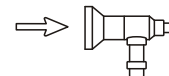

Storz / Olympus



11.001.20

Wolf



11.001.22

ACMI / British Standard



11.001.24

Stryker



11.001.26

MAHE International, Inc. 468 Craighead Street Nashville, TN 37204 USA

Website: [MahelInternational.com](http://MahelInternational.com)

Toll Free (800) 294-7946 Phone (615) 269-7256 Fax (615) 269-4605 Email [info@MahelInternational.com](mailto:info@MahelInternational.com)

SIN-01

1/2005



# Nasopharyngoscope, Telescopes heavy duty

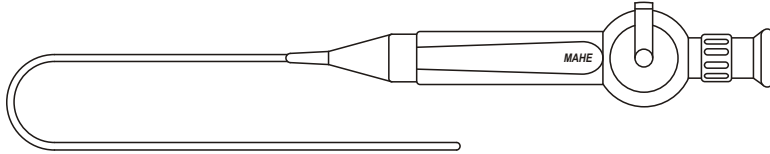

## 2.8 mm Flexible nasopharyngoscope

60.005.02      ● Applicable for pediatrics

Working length:	300 mm
Working Ø:	2.8 mm
Deflection:	up 120°, down 100°
Direction of view:	0°
Field of view:	95°
Depth of focus:	3 mm to 50 mm

## 3.4 mm Flexible nasopharyngoscope

60.005.03      ● 3.4 mm Diameter

Working length:	300 mm
Working Ø:	3.4 mm
Deflection:	up 180°, down 100°
Direction of view:	0°
Field of view:	95°
Depth of focus:	3 mm to 50 mm

## 3.8 mm Flexible nasopharyngoscope

60.005.04      ● 9800 pixel

Working length:	300 mm
Working Ø:	3.8 mm
Deflection:	up 150°, down 150°
Direction of view:	0°
Field of view:	100°
Depth of focus:	3 mm to infinity

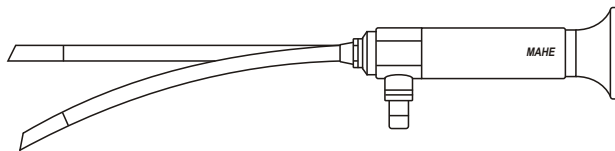

Working Ø:	2,9 mm
Length:	120 mm
Direction of view:	30°
Field of view:	75°

## Telescope heavy duty      Not brake sensitive

60.005.05

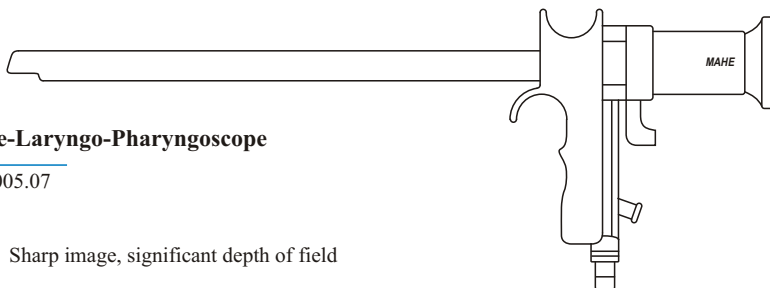

Working Ø:	10 mm
Working length:	153 mm rigid
Direction of view:	90°
Field of view:	60°
Working distance:	15 mm to infinity

## Tele-Laryngo-Pharyngoscope

60.005.07

- Sharp image, significant depth of field
- High performance lumina system
- Two different degrees of magnification: panoramic view and examination of details
- Integrated air channel for prevention of misted objective
- Soakable in disinfection
- Integrated air channel with Luer-lock connection
- Integrated fiberoptic illumination

MAHE International, Inc.    468 Craighead Street    Nashville, TN 37204    USA

**SIN-02**

**Website: [MahelInternational.com](http://MahelInternational.com)**

1/2005

**Toll Free (800) 294-7946    Phone (615) 269-7256    Fax (615) 269-4605    Email [info@MahelInternational.com](mailto:info@MahelInternational.com)**

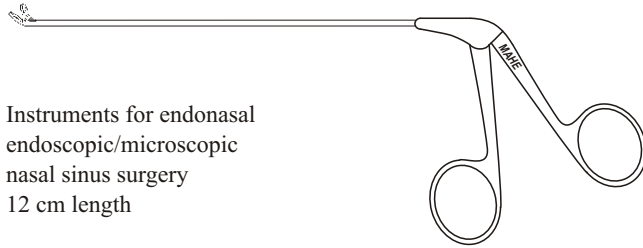

Instruments for endonasal  
endoscopic/microscopic  
nasal sinus surgery  
12 cm length

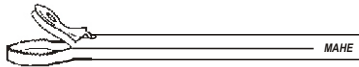

**Blakesley through cutting forceps, straight, 3 mm wide**

60.013.50

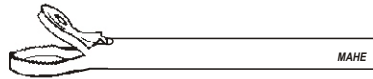

**Blakesley through cutting forceps, straight, 3.5 mm wide**

60.013.51

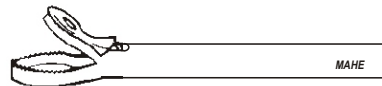

**Blakesley through cutting forceps, straight, 4 mm wide**

60.013.52



**Blakesley through cutting forceps, 45° up-turned, 3 mm wide**

60.013.55



**Blakesley through cutting forceps, 45° up-turned, 3.5 mm wide**

60.013.56



**Blakesley through cutting forceps, 45° up-turned, 4 mm wide**

60.013.57



**Gruenwald through cutting forceps,  
straight, 8 mm x 3 mm**

60.009.01



**Gruenwald through cutting forceps,  
straight, 11.5 mm x 3.5 mm**

60.009.02

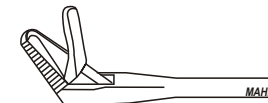

**Gruenwald through cutting forceps,  
45° up-turned, 8 mm x 3 mm**

60.009.03

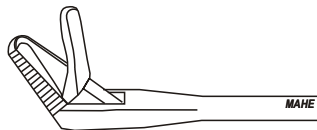

**Gruenwald through cutting forceps,  
45° up-turned, 11.5 mm x 3.5 mm**

60.009.04

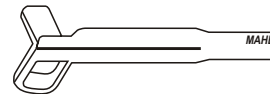

**Antrum Punch, right side downward, forward cutting**

60.014.04

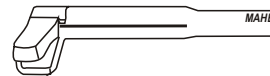

**Antrum Punch, left side downward, forward cutting**

60.014.05

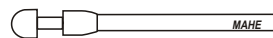

**Circular Punch, 3.5 mm WL 18 cm**

60.014.06

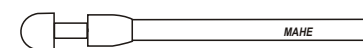

**Circular Punch, 4.5 mm WL 18 cm**

60.014.07



# Forceps

## Biopsy and grasping forceps

60.011.01

Shaft diameter 1,5 mm, oval cupped jaw 2,5 mm, working length 15 cm

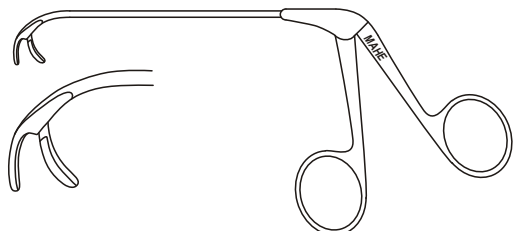
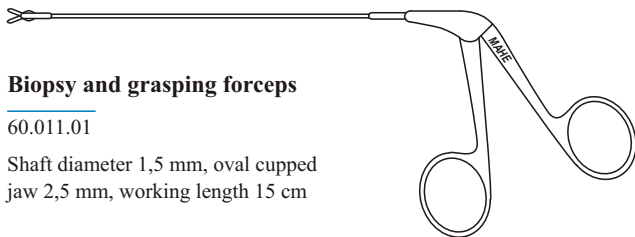

## Antrum grasping forceps

60.011.05

For endonasal removal of cysts and polypi, retrograd opening jaws 120°, working length 10 cm

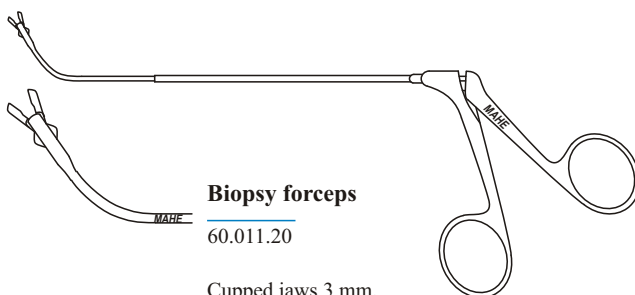

## Biopsy forceps

60.011.20

Cupped jaws 3 mm, 55° upturned, vertical opening

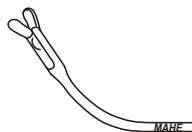

Same, horizontal opening

60.011.21

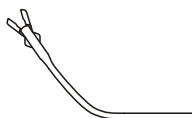

Same, 2 mm, 55° upturned, vertical opening

60.011.23

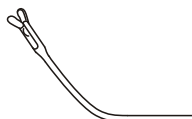

Same, horizontal opening

60.011.24

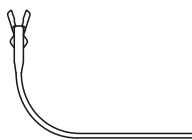

## Biopsy forceps

60.011.25

Cupped jaws, 2mm, 90° upturned, vertical opening



Same, horizontal opening

60.011.26

Working length 10 cm

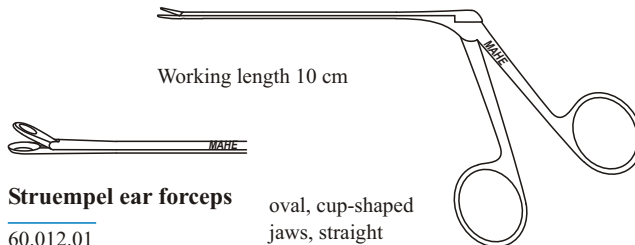

## Struempel ear forceps

60.012.01

oval, cup-shaped jaws, straight



Same, 45° curved up

60.012.02



Same, 90° curved up

60.012.03



## Bellucci scissors, working length 10 cm, straight

60.012.10

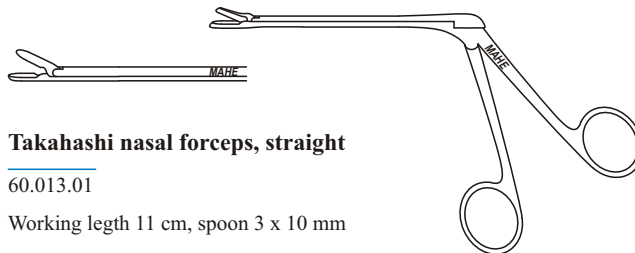

## Takahashi nasal forceps, straight

60.013.01

Working length 11 cm, spoon 3 x 10 mm



Working length 11 cm, spoon 3 x 10 mm

## Takahashi nasal forceps, 30° upturned

60.013.03



## Struycken nasal through cutting forceps, working length

60.013.05



## Hartmann nasal through cutting forceps, working length

60.013.10 Fig. ①

60.013.11 Fig. ②

60.013.12 Fig. ③

60.013.13 Fig. ④

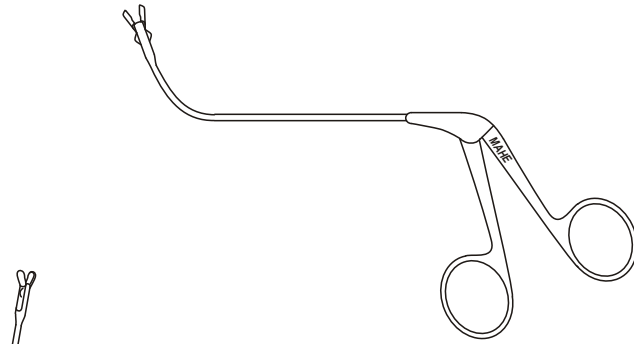

**Biopsy forceps, oval cupped jaws**

2.6 mm	60.011.50
4.0 mm	60.011.70

110° upturned, horizontal opening

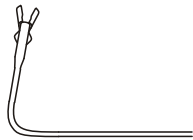

Same

2.6 mm	60.011.51
4.0 mm	60.011.71

110° upturned, vertical opening

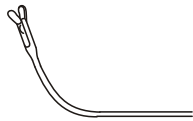

Same

2.6 mm	60.011.53
4.0 mm	60.011.73

70° upturned, horizontal opening

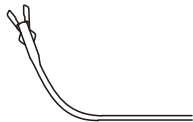

Same

2.6 mm	60.011.54
4.0 mm	60.011.74

70° upturned, vertical opening

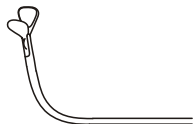

**Polyp grasping forceps**

60.011.58

Cupped jaws 3 x 1,5 mm, pear shaped, horizontal opening, 80° upturned

Same

60.011.59

80° curved to left side

Same

60.011.60

80° curved to right side

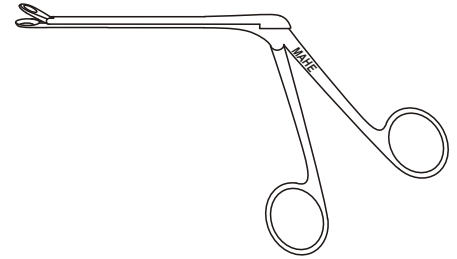

*Blakesley nasal forceps*



**Straight, working length 11 cm**

3,5 x 8,0 mm	60.013.20	Fig. ①
4,0 x 10,5 mm	60.013.21	Fig. ②
5,0 x 12,0 mm	60.013.22	Fig. ③



**45° upturned, working length 11 cm**

3,5 x 8,0 mm	60.013.25	Fig. ①
4,0 x 10,5 mm	60.013.26	Fig. ②
5,0 x 12,0 mm	60.013.27	Fig. ③



**90° upturned, working length 11 cm**

3,5 x 8,0 mm	60.013.30	Fig. ①
4,0 x 10,5 mm	60.013.31	Fig. ②
5,0 x 12,0 mm	60.013.32	Fig. ③



**Struempel-Voss nasal forceps, 45° upturned, extra delicate, working length 11 cm**

60.013.34



# Forceps and Scissors

Working length 10 cm,

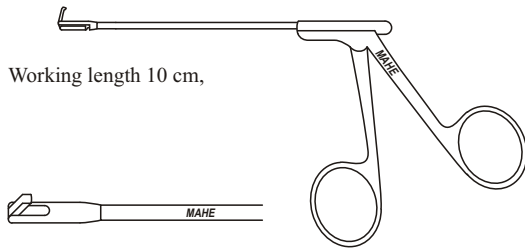

### Antrum punch, upside backward cutting

Medium	60.014.01
Pediatric	60.014.11

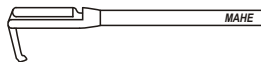

Same, left side backward cutting

Medium	60.014.02
Pediatric	60.014.12



Same, right side backward cutting

Medium	60.014.03
Pediatric	60.014.13

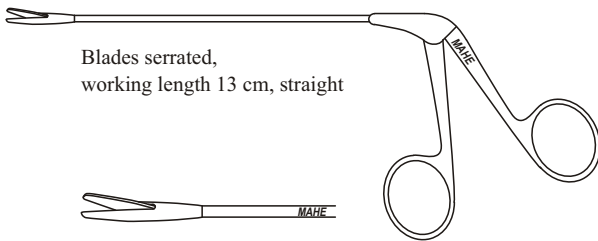

Blades serrated,  
working length 13 cm, straight

### Nasal scissors

60.015.01



Same, curved left

60.015.02



Same, curved right

60.015.03

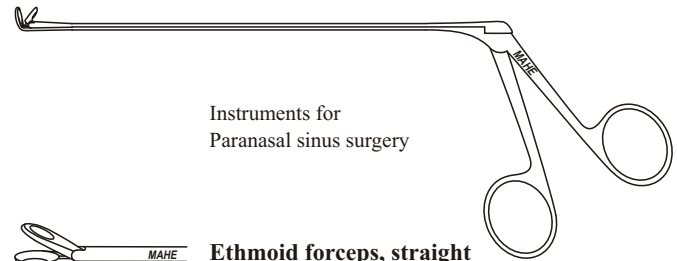

Instruments for  
Paranasal sinus surgery

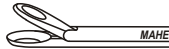

### Ethmoid forceps, straight

Working length	
13 cm	60.016.01
16 cm	60.016.02
19 cm	60.016.03

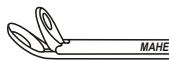

### Ethmoid forceps, 60° upturned

Working length	
13 cm	60.016.10
16 cm	60.016.11
19 cm	60.016.12



### Ethmoid forceps, 90° upturned

Working length	
13 cm	60.016.15
16 cm	60.016.16
19 cm	60.016.17

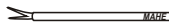

### Ethmoid scissors, straight

Working length	
13 cm	60.016.20
16 cm	60.016.21
19 cm	60.016.22

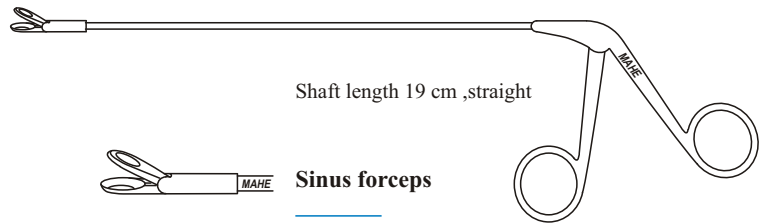

Shaft length 19 cm, straight

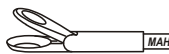

### Sinus forceps

60.016.40



Same, 60° upturned

60.016.41



Same, 90° upturned

60.016.42

MAHE International, Inc. 468 Craighead Street Nashville, TN 37204 USA

[Website: MahelInternational.com](http://Website: MahelInternational.com)

SIN-06

1/2005

Toll Free (800) 294-7946 Phone (615) 269-7256 Fax (615) 269-4605 Email [info@MahelInternational.com](mailto:info@MahelInternational.com)

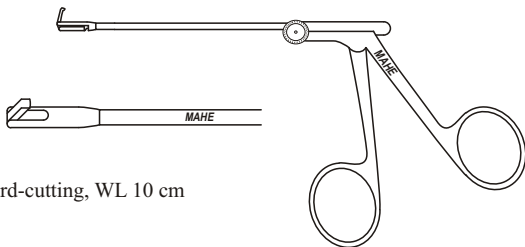

Backward-cutting, WL 10 cm

### Ostrum antrum punch, rotatable

60.017.10	2,5 mm
60.017.11	1,5 mm

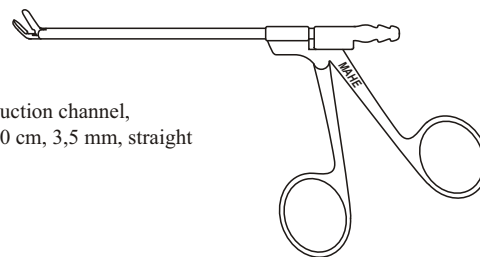

With integrated suction channel,  
working length 10 cm, 3,5 mm, straight



### Takahashi suction punch for biopsy and grasping

3,5 mm	60.018.20
2,5 mm	60.018.22



### Blakesley suction punch for biopsy and grasping

3,5 mm	60.018.30
2,5 mm	60.018.32

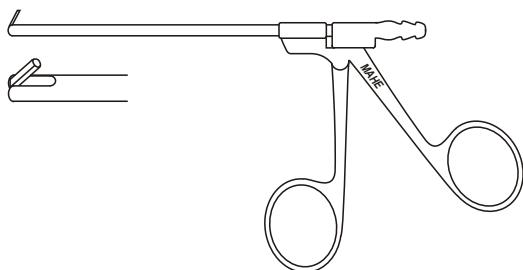

With integrated suction channel, working length 10 cm,  
shaft diameter 4 mm, bite 2 mm, straight, upside backward cutting



Same, 45° upturned

3,5 mm	60.018.26
2,5 mm	60.018.28



Same, 45° upturned

3,5 mm	60.018.36
2,5 mm	60.018.38

### Antrum suction punch

60.018.01

Same, right side backward cutting

60.018.02

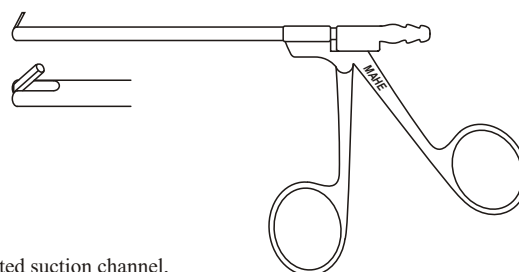

With integrated suction channel,  
working length 10 cm, shaft diameter 5 mm,  
bite 2,5 mm, straight, upside backward cutting

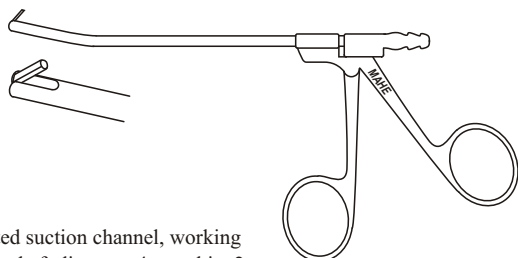

With integrated suction channel, working  
length 10 cm, shaft diameter 4 mm, bite 2  
mm, upturned, upside backward cutting

### Antrum suction punch

60.018.40

Same, left side backward cutting

60.018.41

Same, right side backward cutting

60.018.42

### Antrum suction punch

60.018.05



# Suction and Irrigation Handle and Punches

For use with suction and irrigation sheaths 60.019.10 - 60.019.17

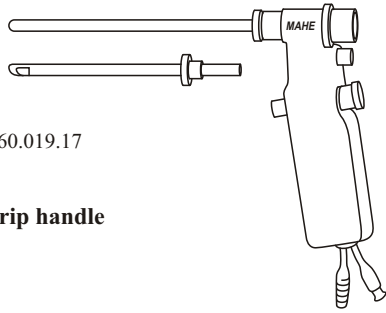

## Suction and Irrigation grip handle

60.019.00

## Suction and irrigation sheath exchangeable for

telescopes 2,7 mm Ø

0°	60.019.10
30°	60.019.11
70°	60.019.12

telescopes 4 mm Ø

0°	60.019.15
30°	60.019.16
70°	60.019.17

Working length 14 cm,  
4 mm wide, 90° upbiting

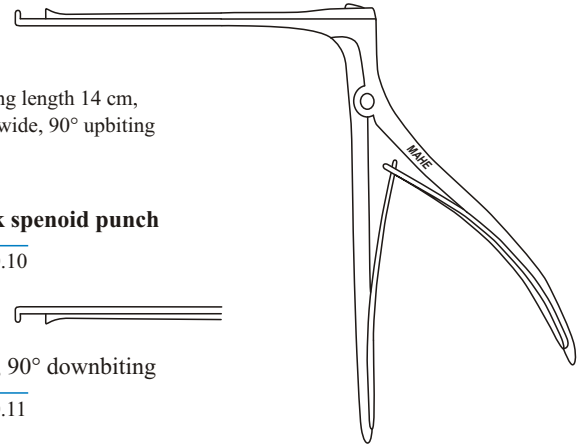

## Hajek spenoid punch

60.020.10



Same, 90° downbiting

60.020.11



Same, 45° upbiting backwards

60.020.12



## Citelli atrum punch, through-cutting

60.020.01	Fig. ①
60.020.02	Fig. ②
60.020.03	Fig. ③

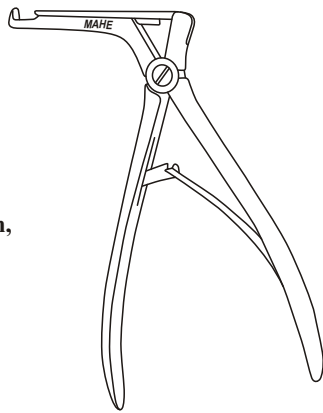

Working length 9 cm, 2 mm wide,  
for endonasal fenestration with children,  
90° throughbiting upwards

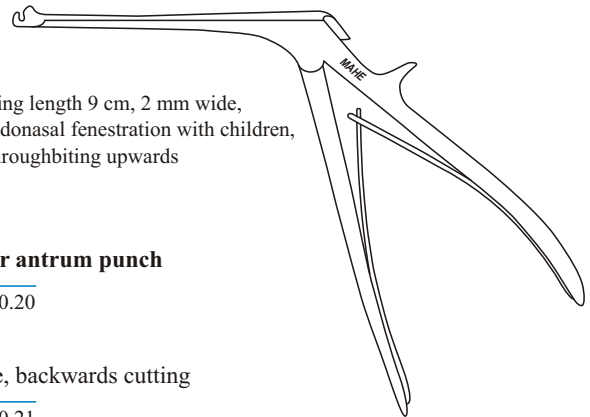

## Beyer antrum punch

60.020.20

Same, backwards cutting

60.020.21

4 x 4 mm, 45° downbiting backward,  
working length 14 cm

## Hajek-Kofler spenoid punch

60.020.05

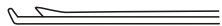

Same, 45° upbiting forward

60.020.06

slender pattern, 360° rotatable,  
17 cm shaft length

## Hajek-Kofler spenoid punch

60.020.25

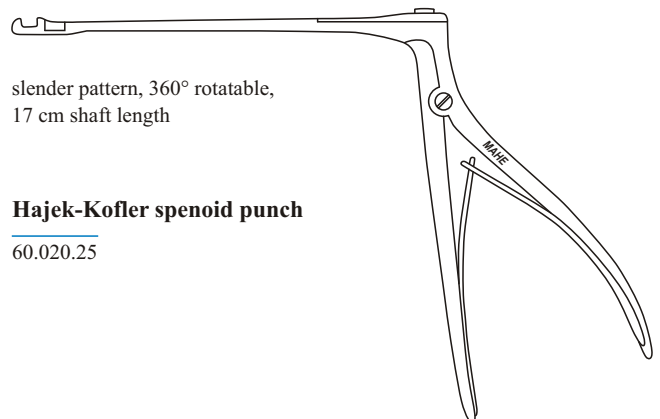

MAHE International, Inc. 468 Craighead Street Nashville, TN 37204 USA

SIN-08

Website: [MahelInternational.com](http://MahelInternational.com)

1/2005

Toll Free (800) 294-7946 Phone (615) 269-7256 Fax (615) 269-4605 Email [info@MahelInternational.com](mailto:info@MahelInternational.com)

# Suction Tubes and Accessories

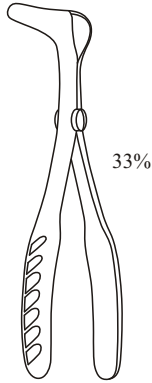

**Hartmann nasal speculum, 15 cm**

Small size	Large size
60.021.01	60.021.03

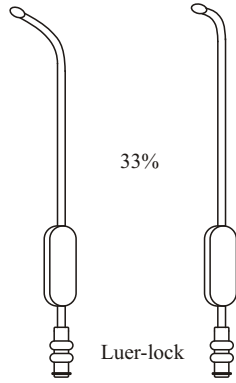

**v. Eicken antrum cannula, 15 cm**

O.D.	Long curved	Short curved
2,5 mm	60.022.01	60.022.03
3,0 mm	60.022.02	60.022.04
4,00 mm	60.022.05	60.022.06



**Septum needle, angular, 0,8 mm, Luer-lock**

60.022.10
-----------

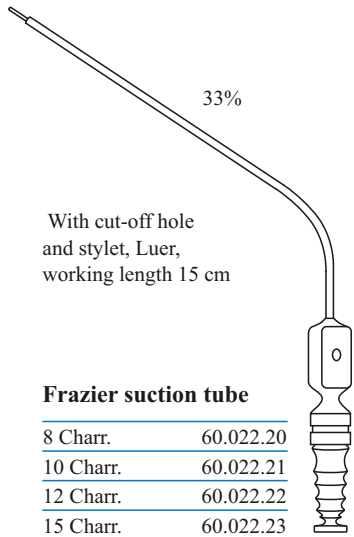

With cut-off hole and stylet, Luer, working length 15 cm

**Frazier suction tube**

8 Charr.	60.022.20
10 Charr.	60.022.21
12 Charr.	60.022.22
15 Charr.	60.022.23

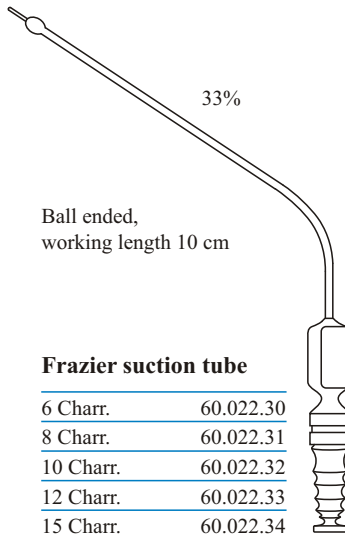

Ball ended, working length 10 cm

**Frazier suction tube**

6 Charr.	60.022.30
8 Charr.	60.022.31
10 Charr.	60.022.32
12 Charr.	60.022.33
15 Charr.	60.022.34

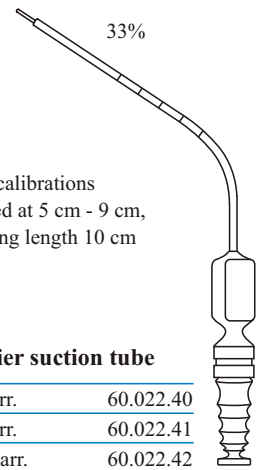

With calibrations marked at 5 cm - 9 cm, working length 10 cm

**Frazier suction tube**

6 Charr.	60.022.40
8 Charr.	60.022.41
10 Charr.	60.022.42

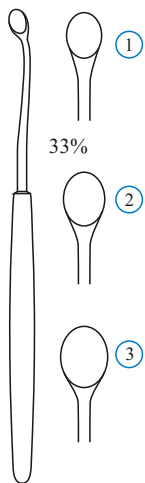

**Antrum curette, 19 cm, oval**

60.023.01	Fig. ①
60.023.02	Fig. ②
60.023.03	Fig. ③

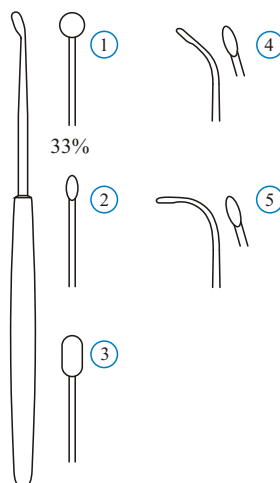

**Antrum curette, 19 cm, round, small size**

60.023.05	Fig. ①
-----------	--------

Same, oblong, small size

60.023.06	Fig. ②
-----------	--------

Same, oblong, large size

60.023.07	Fig. ③
-----------	--------

**Sinus frontal curette, 19 cm, oblong, small size**

55°	60.023.10	Fig. ④
90°	60.023.11	Fig. ⑤

Sin-09

MAHE International, Inc. 468 Craighead Street Nashville, TN 37204 USA

**Website: [MahelInternational.com](http://MahelInternational.com)**

Toll Free (800) 294-7946 Phone (615) 269-7256 Fax (615) 269-4605 Email [info@MahelInternational.com](mailto:info@MahelInternational.com)

**SIN-09**

1/2005



# Curettes and Accessories

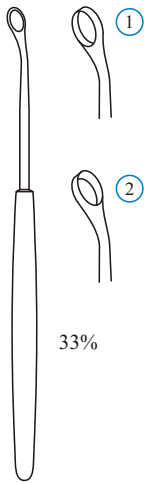

33%

**Antrum curette, 19 cm**

Forward cutting

60.023.20 Fig. ①

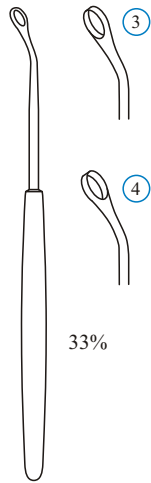

33%

Small, forward cutting

60.023.22 Fig. ③



Backward cutting

60.023.21 Fig. ②



Small, backward cutting

60.023.23 Fig. ④

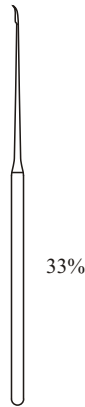

33%

**Sickle knife, pointed, 16 cm**

60.023.30

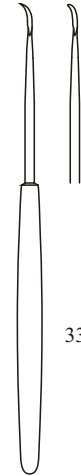

33%

**Sickle knife, 19 cm, pointed**

60.023.35

Same, tip rounded, blunt

60.023.40



**Frontal sinus rasp**

Strong pattern

60.023.50

Slender pattern

60.023.51

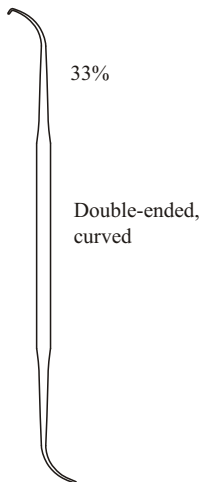

33%

Double-ended,  
curved

**Frontal sinus ostium seeker**

60.023.60

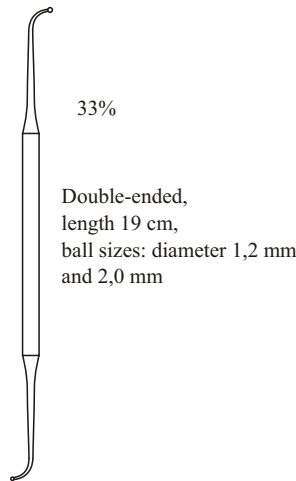

33%

Double-ended,  
length 19 cm,  
ball sizes: diameter 1,2 mm  
and 2,0 mm

**Maxillary sinus ostium seeker**

60.023.61

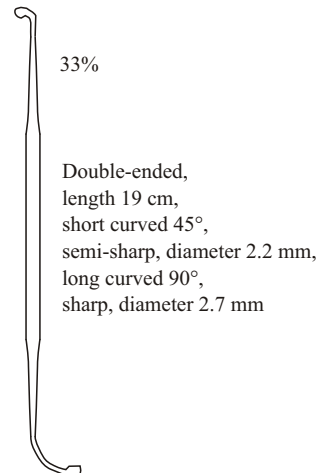

33%

Double-ended,  
length 19 cm,  
short curved 45°,  
semi-sharp, diameter 2.2 mm,  
long curved 90°,  
sharp, diameter 2.7 mm

**Double-ended Oval Curette**

60.023.63

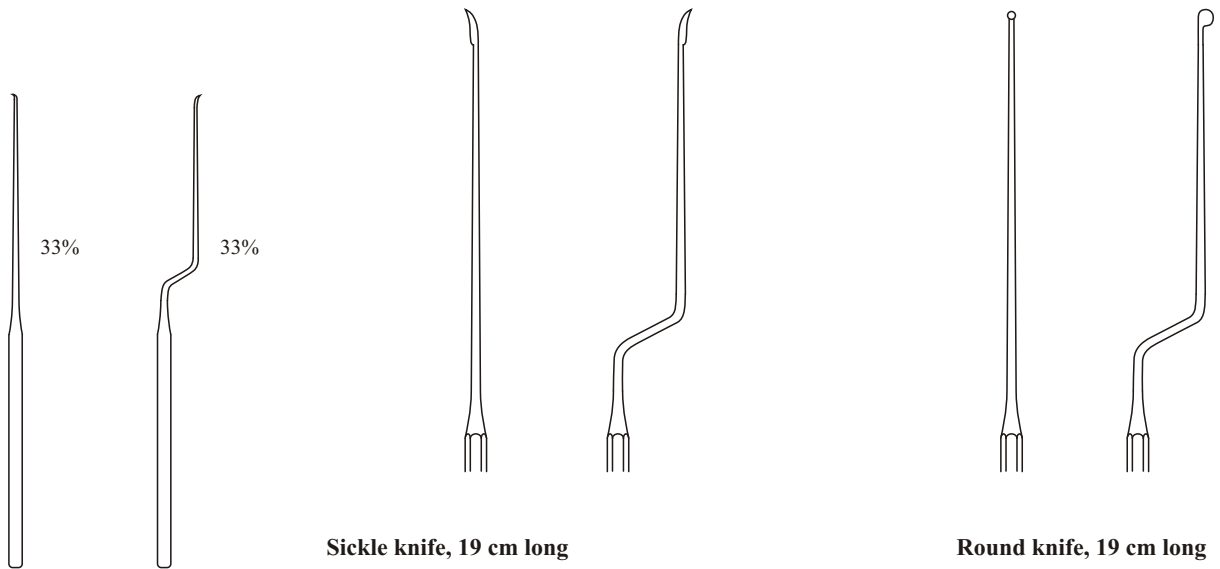
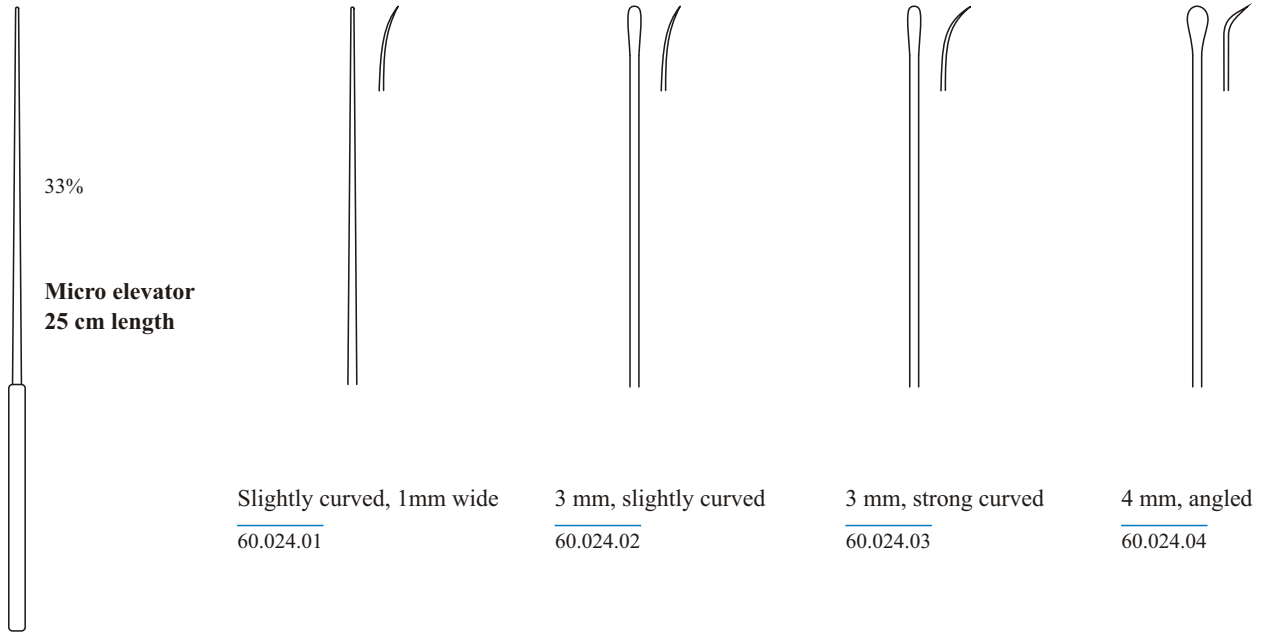

Ø	Shaft straight	Shaft bajonet
1,5 mm	60.024.20	60.024.21
2,0 mm	60.024.22	60.024.23

Straight	Bajonet
60.024.30	60.024.31



# Curettes

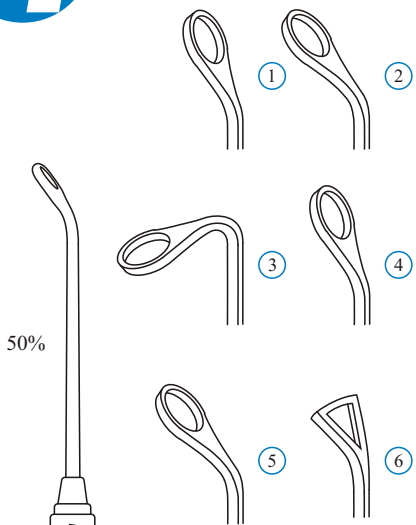

**Coakley antrum curette, 17 cm**

- 60.025.01 Fig. ①
- 60.025.02 Fig. ②
- 60.025.03 Fig. ③
- 60.025.04 Fig. ④
- 60.025.05 Fig. ⑤
- 60.025.06 Fig. ⑥



**Faulkner antrum curette double-ended, 21 cm**

60.025.20

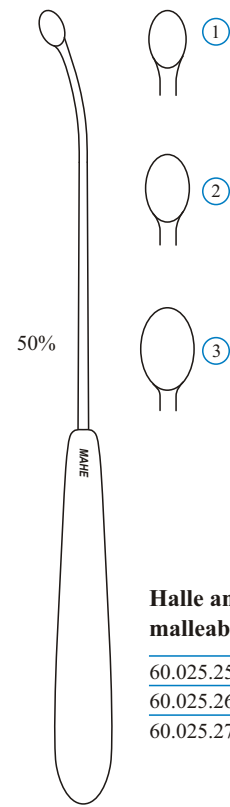

**Halle antrum curette malleable, 21 cm**

- 60.025.25 Fig. ①
- 60.025.26 Fig. ②
- 60.025.27 Fig. ③

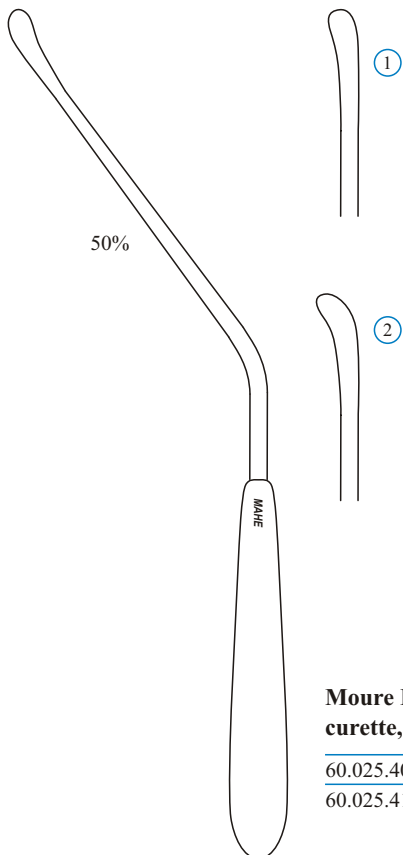

**Moure Ethmoid curette, 22, 5 cm**

- 60.025.40 Fig. ①
- 60.025.41 Fig. ②

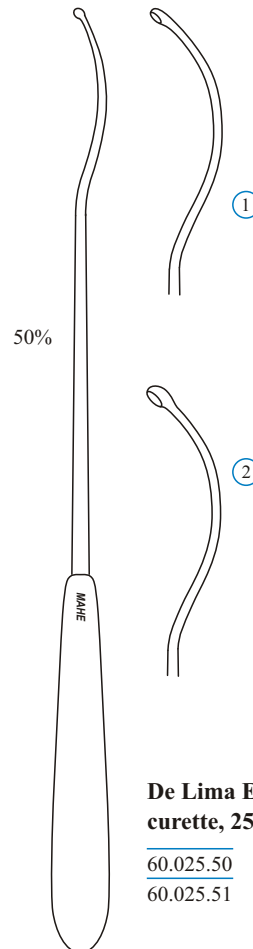

**De Lima Ethmoid curette, 25 cm**

- 60.025.50 Fig. ①
- 60.025.51 Fig. ②

MAHE International, Inc. 468 Craighead Street Nashville, TN 37204 USA

**Website: [MahelInternational.com](http://MahelInternational.com)**

**SIN-12**

1/2005

**Toll Free (800) 294-7946 Phone (615) 269-7256 Fax (615) 269-4605 Email [info@MahelInternational.com](mailto:info@MahelInternational.com)**

# Retractors

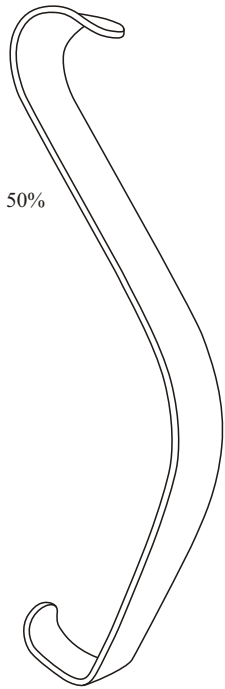

**Hajek lip retractor, 18 cm**

60.026.01

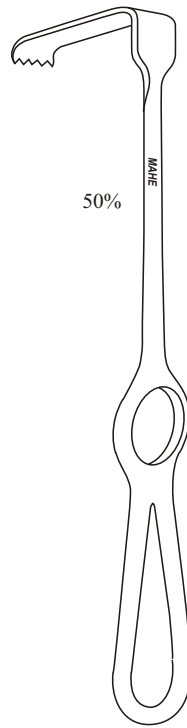

**Bruenings-Brunk antrum retractor,  
with teeth, 19 cm**

60.026.05

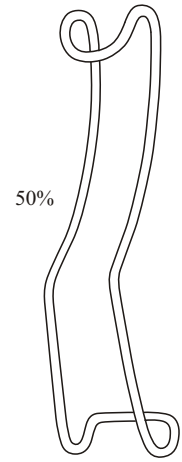

**Sternberg lip retractor**

12 cm	60.026.08
14 cm	60.026.10
16 cm	60.026.12

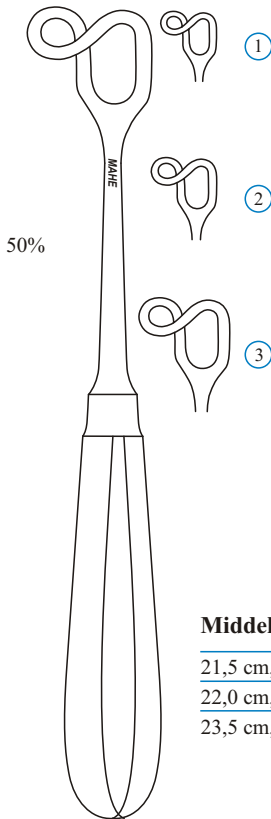

**Middeldorp retractor**

21,5 cm, 14 x 17 mm	60.026.20
22,0 cm, 20 x 22 mm	60.026.21
23,5 cm, 26 x 30 mm	60.026.22

Fig. ①  
Fig. ②  
Fig. ③

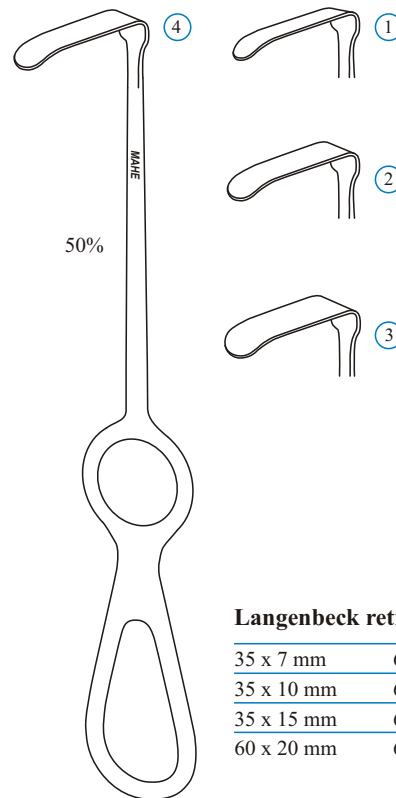

**Langenbeck retractor, 21 cm**

35 x 7 mm	60.026.30
35 x 10 mm	60.026.31
35 x 15 mm	60.026.32
60 x 20 mm	60.026.33

Fig. ①  
Fig. ②  
Fig. ③  
Fig. ④



# Bougies, Retractors and Rasps



**Ritter-Halle sinus frontal bougie**  
**14,5 cm**

Ø	
2,5 mm	60.027.01
3,0 mm	60.027.02
4,0 mm	60.027.03
5,0 mm	60.027.04

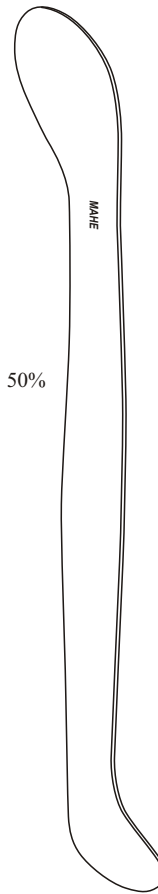

**Orbital retractor**  
**23,5 cm length**  
60.027.10

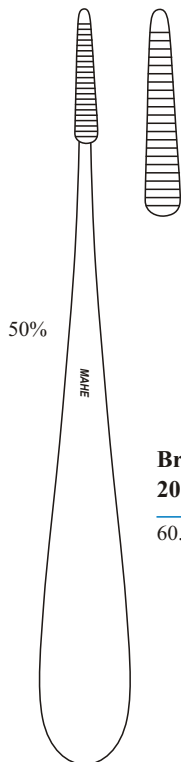

**Brawley antrum rasp**  
**20 cm, blunt**  
60.028.01

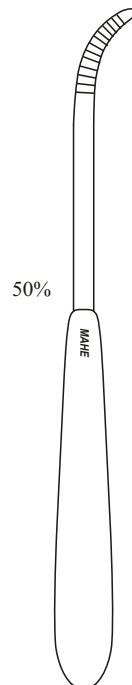

**Wiener antrum rasp, curved, with trocar tip, 18 cm**  
60.028.10

MAHE International, Inc. 468 Craighead Street Nashville, TN 37204 USA

**SIN-14**

**Website: [MahelInternational.com](http://MahelInternational.com)**

1/2005

**Toll Free (800) 294-7946 Phone (615) 269-7256 Fax (615) 269-4605 Email [info@MahelInternational.com](mailto:info@MahelInternational.com)**

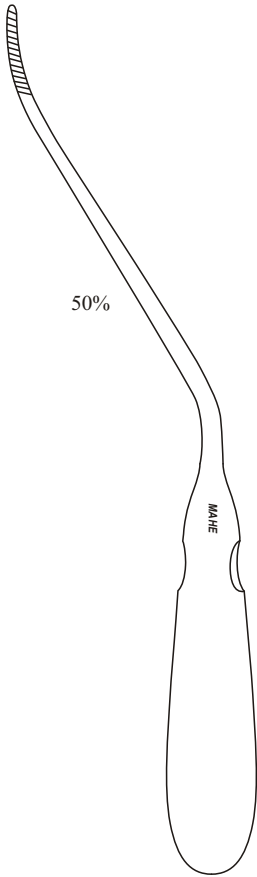

**Watson-Williams antrum rasp**  
**23 cm, blunt**  
60.028.15

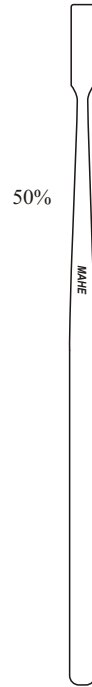

**West chisel**  
**18 cm, 4 mm wide**  
60.029.10

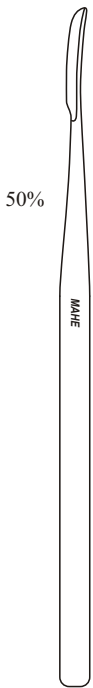

**West gouge**  
**18 cm, 4 mm wide**  
60.029.30

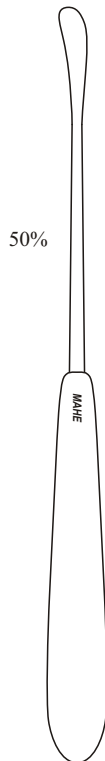

**Sewall antrum elevator**  
**19,5 cm**  
60.030.10



**Freer elevator**  
**double-ended, 20 cm**  
60.030.15



## Burs

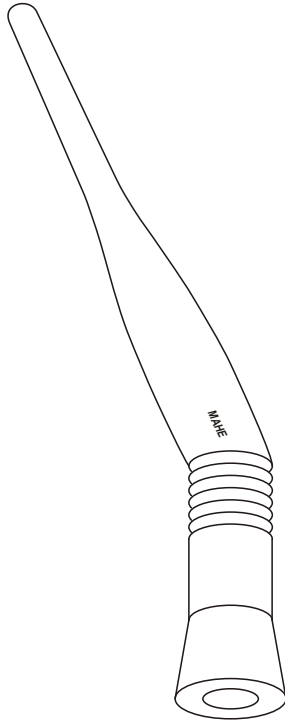

### Handpiece, angled

60.040.00

Long slender shape, for use with straight shaft burs,  
Ø 2,35 mm, length 9,5 cm

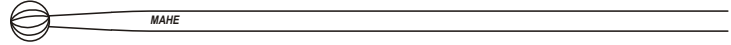

**Standard straight shaft burs, length 9,5 cm,  
stainless set with 10 pieces, sizes 14 - 70**

60.041.00

**Diamond straight shaft burs, length 9,5 cm,  
stainless set with 10 pieces, sizes 14 - 70**

60.042.00



Size	Ø	Standard	Diamond
14 mm	1,4 mm	60.041.14	60.042.14
18 mm	1,8 mm	60.041.18	60.042.18
23 mm	2,3 mm	60.041.23	60.042.23
27 mm	2,7 mm	60.041.27	60.042.27
31 mm	3,1 mm	60.041.31	60.042.31
35 mm	3,5 mm	60.041.35	60.042.35
40 mm	4,0 mm	60.041.40	60.042.40
45 mm	4,5 mm	60.041.45	60.042.45
50 mm	5,0 mm	60.041.50	60.042.50
70 mm	7,0 mm	60.041.70	60.042.70

Our burs and trephines have blades running diagonal around the bur-head; this allows straight cutting

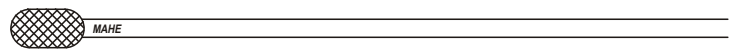

**Cutting bur, cylinder shape  
straight shaft, length 9,5 cm, stainless**

Ø	
5,0 mm	60.043.50
7,0mm	60.043.70

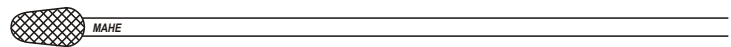

**Cutting bur, "bud", straight shaft  
length 9,5 cm, stainless, 5,0 mm Ø**

Ø	
5,0 mm	60.044.50
7,0 mm	60.044.70

MAHE International, Inc. 468 Craighead Street Nashville, TN 37204 USA

**SIN-16**

**Website: [MahelInternational.com](http://MahelInternational.com)**

1/2005

**Toll Free (800) 294-7946 Phone (615) 269-7256 Fax (615) 269-4605 Email [info@MahelInternational.com](mailto:info@MahelInternational.com)**

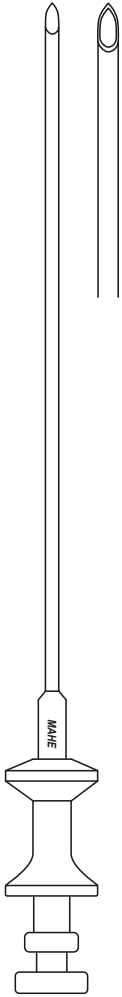

**Lichtwitz antrum trocar needle,  
working length 10 cm, outer-Ø 1,5 mm**

Outer-Ø	
1,5 mm	60.050.01
1,8 mm	60.050.02
2,0 mm	60.050.03

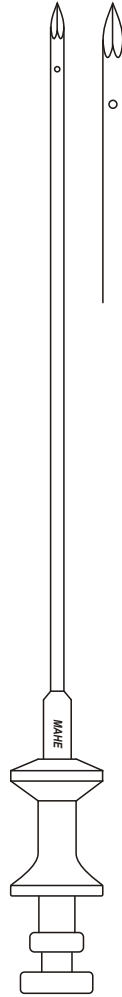

**Lichtwitz-v.Eicken  
antrum trocar needle**

Outer-Ø	
1,5 mm	60.050.10
1,8 mm	60.050.11
2,0 mm	60.050.12

With trocar tip  
and sleeve holes,  
working length 10 cm

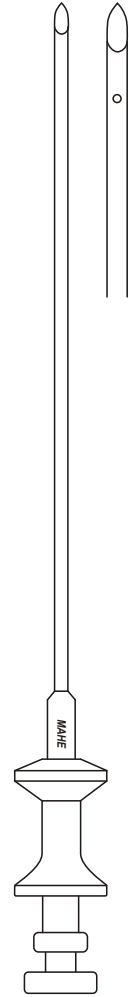

**Vogel  
antrum trocar needle**

Outer-Ø	
1,5 mm	60.050.20
1,8 mm	60.050.21
2,0 mm	60.050.22

With closed tip and sleeve holes,  
working length 10 cm



# Cannula and Cotton Applicator

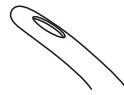
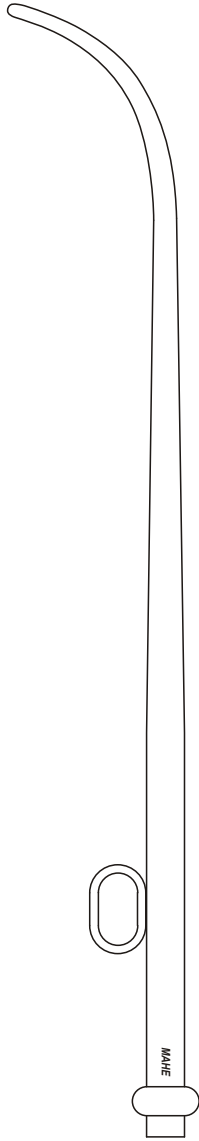

**Siebenmann antrum cannula  
upward hole, 15 cm**

$\varnothing$	
1,5 mm	60.050.50
1,7 mm	60.050.52
2,0 mm	60.050.54
2,5 mm	60.050.56
3,0 mm	60.050.58

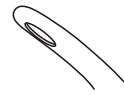

**Siebenmann antrum cannula  
downward hole, 15 cm, sizes 1,5 - 3,0 mm  $\varnothing$**

$\varnothing$	
1,5 mm	60.050.64
1,7 mm	60.050.66
2,0 mm	60.050.68
2,5 mm	60.050.70
3,0 mm	60.050.72



**Silicone irrigation tube**  
60.050.80

Autoclavable, length 30 cm, complete  
with Luer-lock connectors on both ends



**Cotton applicator for anesthesia,  
triangular serrated, diam. 0,9 mm 7,5 cm**  
60.050.90

MAHE International, Inc. 468 Craighead Street Nashville, TN 37204 USA

**Website: [MahelInternational.com](http://MahelInternational.com)**

**SIN-18**

1/2005

**Toll Free (800) 294-7946 Phone (615) 269-7256 Fax (615) 269-4605 Email [info@MahelInternational.com](mailto:info@MahelInternational.com)**