

Laparoscopy



MAHE International, Inc.

Made in Germany

CE / ISO 9001

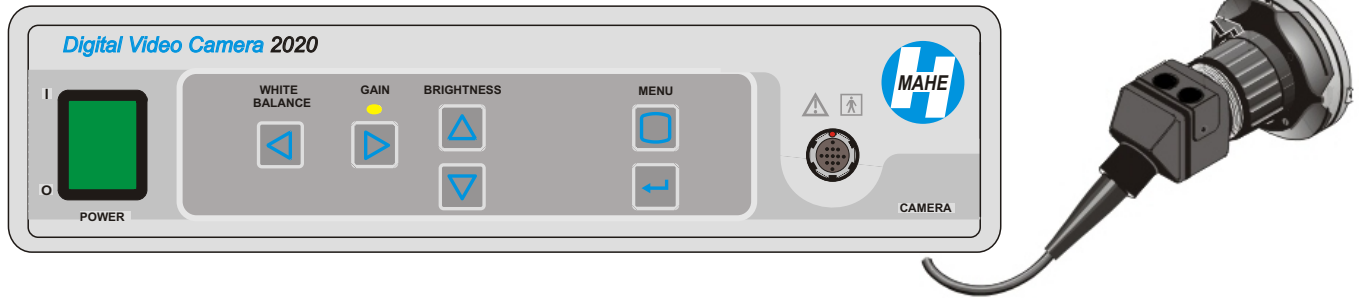

10.900.30

Digital single chip camera for endoscopy with very high resolution

- Multilevel enhance function with
- Freeze function with live image (Picture in Picture)
- Optical adapters with anti-moire filters for fiberscopes (optional)
- Programmable camera head buttons
- Fully immersible camera head and
- Easy replacement of camera head cable
- Automatic window adjustment for W/B and exposure
- Very fast electronic shutter speed and response time
- Optional keyboard hook-up
- On-screen patient data input from keyboard
- On-screen menu control from keyboard or front panel
- Five user files with preset parameters
- On-screen time/date clock and stop watch
- RS-232C / S-Video link for computer communication
- Multiple video outputs: composite video, Y/C and RGB
- Network communication with other system devices (optional)
- Manual shutter speed control

Camera Specifications

Image Device	1/3" CCD Sensor Digital Signal Process
Horizontal Resolution	752 CCD CCD Lines
Number of Pixels	470,000 PAL / 410,000 NTSC
Minimum Illumination	Less than 1.5 Lux
White Balance	Auto adjust in less than 1 second
Signal/ Noise Ratio	Greater than 50dB @ AGC off
Video Outputs	2 x BNC / 2 x S-VHS / 1 x RGB
Weight Camera / Head	2.1 kg / 46 g
Dimensions	295 (W) x 75 (H) x 253(D) mm



180 W Xenon light source

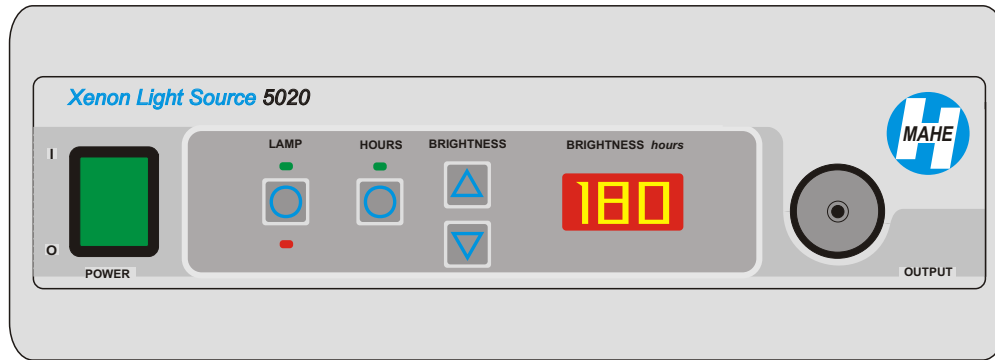

- Electronically controlled light intensity
- Audible overheating alarm
- Easy lamp replacement

10.912.00

Light Source Specifications

Lamp Type	OSRAM XBOR R180/45
Lamp Power	180 W
Lamp Color Temperature	6000° K
Lamp Life	500 hours minimum
Weight	5.5 kg
Dimensions	295 (W) x 135 (H) x 253(D)

20 l High Flow Insufflator

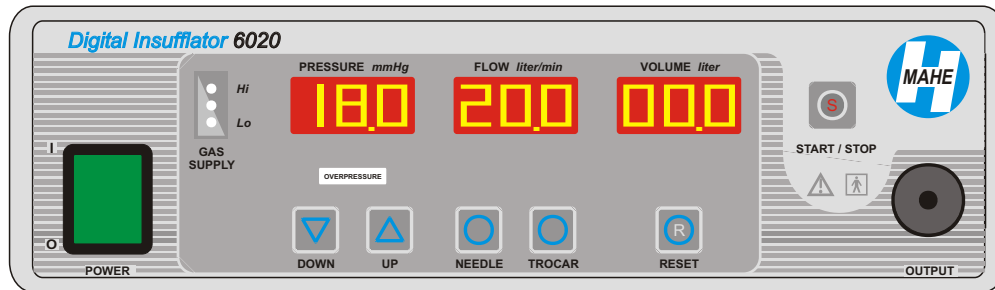

- 20 l high flow microprocessor controlled
- Audible alarm and digital display
- 3 layers of safety features

10.920.00

Insufflator Specifications

Flow Rate	0-30 Liter/Min
Max. Input Gas Pressure	2000 psi
Safety System Level 1	Constant within ± 1 mm Hg preset pressure
Safety System Level 2	Automatic vent at ± 3 mm above preset pressure
Safety System Level 3	vents to zero abdomen pressure at 25mm Hg
Weight	4.5 kg
Dimensions	

MAHE International, Inc. 468 Craighead Street Nashville, TN 37204 USA

Website: MahelInternational.com

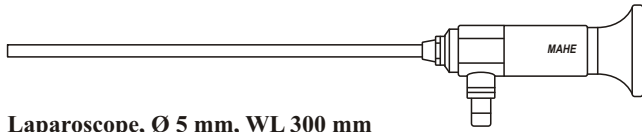

Laparoscope, Ø 5 mm, WL 300 mm

Direction of view	
0°	10.005.00A
30°	10.005.30A
45°	10.005.45A

AUTOCLAVE
134° C / 273° F

Laparoscope, Ø 6.5 mm, WL 300 mm

Direction of view	
0°	10.006.00A
30°	10.006.30A

Laparoscope, Ø 10 mm, WL 310 mm

Direction of view	
0°	10.010.00A
30°	10.010.30A
45°	10.010.45A

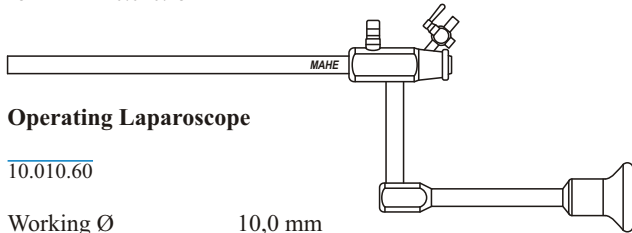

Operating Laparoscope

10.010.60	
Working Ø	10,0 mm
Length	280 mm
Instrument channel	6 mm
Direction of view	0°

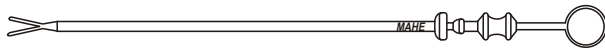

Ring applicator

10.010.65	Working Ø 6 mm, AL 330 mm
10.010.66	Working Ø 7 mm, WL 290 mm
10.010.67	Insert Cones for 10.010.65, 10.010.66
10.010.68	Applier for 10.010.65, 10.010.66

Silicon Rings, 50 pcs./pack

10.010.70

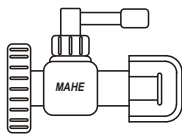

**Stop cock for Ø10 mm Operating Laparoscope
incl. 1 stop cock and sealing cap**
10.010.72

Sealing cap for stop cock
10.010.74

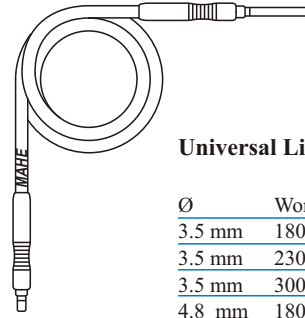





Universal Light cable

Ø	Working length	
3.5 mm	1800 mm	11.000.00
3.5 mm	2300 mm	11.000.02
3.5 mm	3000 mm	11.000.04
4.8 mm	1800 mm	11.000.06
4.8 mm	2300 mm	11.000.08
4.8 mm	3000 mm	11.000.10

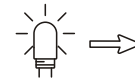
With silicone-rubber sheath, autoclavable, waterproof, very flexible, heat resistant from approx. -60° to approx. +180° Centigrade



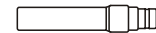

Light Source - Adapter

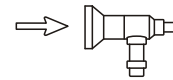

Storz		11.001.00
Olympus		11.001.02
Wolf / Dyonics		11.001.04
ACMI / British Standard		11.001.06

Endoscope - Adapter



Storz / Olympus		11.001.20
Wolf		11.001.22
ACMI / British Standard		11.001.24
Stryker		11.001.26



Trocar-Systems and Accessories

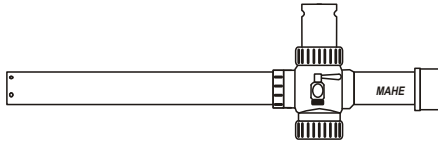

Trumpet Valve Cannula

	with metal smooth sleeve	with metal threaded sleeve
Inside-Ø		
5.5 mm	13.000.05	13.002.05
11.0 mm	13.000.11	13.002.11
12.5 mm	13.000.12	13.002.12



LITE-LINE Cannula with silicone seal with stopcock

	with metal smooth sleeve	with metal threaded sleeve
Inside-Ø		
5.5 mm	12.005.05	12.007.05
11.0 mm	12.005.11	12.007.11
12.5 mm	12.005.12	12.007.12

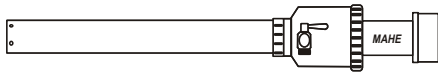

Automatic Valve Cannula

	with metal smooth sleeve	with metal threaded sleeve
Inside-Ø		
3.5 mm	13.005.03	13.007.03
5.5 mm	13.005.05	13.007.05
7.5 mm	13.005.07	13.007.07
11.0 mm	13.005.11	13.007.11
12.5 mm	13.005.12	13.007.12



LITE-LINE silicone seals

5.5 mm	12.016.05
11.0/12.5 mm	12.016.11

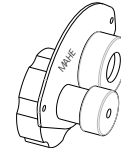

LITE-LINE sliding reducer

11.0 mm - 5.5 mm	12.075.11
------------------	-----------

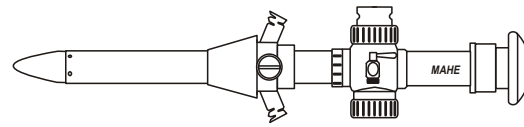

Hasson Cannula Set

Inside-Ø	with Trumpet Valve	with Automatic Valve	With manual lever and Automatic Valve
5.5 mm	13.020.05	13.022.05	13.024.05
11.0 mm	13.020.11	13.022.11	13.024.11
12.5 mm	13.020.12	13.022.12	13.024.12

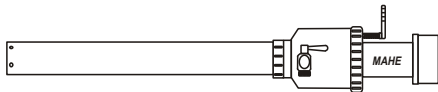

Automatic Cannula with manual lever

	with metal smooth sleeve	with metal threaded sleeve
Inside-Ø		
5.5 mm	13.010.05	13.012.05
7.5 mm	13.010.07	13.012.07
11.0 mm	13.010.11	13.012.11
12.5 mm	13.010.12	13.012.12

Accessories for Hasson Cannula

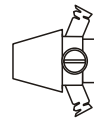

Hasson Cone



Fascia Holder



LITE-LINE Cannula with silicone seal w/o stopcock

	with metal smooth sleeve	with metal threaded sleeve
Inside-Ø		
5.5 mm	12.000.05	12.002.05
11.0 mm	12.000.11	12.002.11
12.5 mm	12.000.12	12.002.12

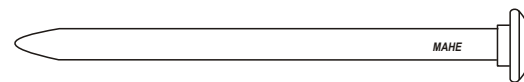

Obturator

Outside-Ø	Hasson Cone	Obturator	Fascia Holder
5.5 mm	13.026.05	13.028.05	13.030.05
11.0 mm	13.026.11	13.028.11	13.030.11
12.5 mm	13.026.12	13.028.12	13.030.12

MAHE International, Inc. 468 Craighead Street Nashville, TN 37204 USA

L-04

Website: MahelInternational.com

1/2005

Toll Free (800) 294-7946 Phone (615) 269-7256 Fax (615) 269-4605 Email info@MahelInternational.com

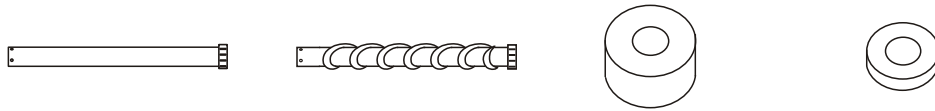

Accessories for Cannula, WL 100 mm, custom lengths available upon request

Inside-Ø	Smooth sleeve	Threaded sleeve	Sealing caps 10/pack	O-Rings 10/pack
5.5 mm	13.032.05	13.034.05	13.036.05	13.038.05
7.5 mm	13.032.07	13.034.07	13.036.07	13.038.07
11.0 mm	13.032.11	13.034.11	13.036.11	13.038.11
12.5 mm	13.032.12	13.034.12	13.036.12	13.038.12

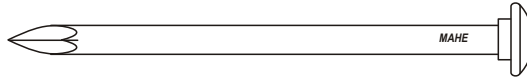

Trocar, pyramidal point

Outside-Ø	
5.5 mm	13.050.05
7.5 mm	13.050.07
11.0 mm	13.050.11
12.5 mm	13.050.12

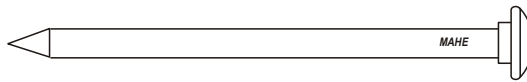

Trocar, conical point

Outside-Ø	
5.5 mm	13.055.05
7.5 mm	13.055.07
11.0 mm	13.055.11
12.5 mm	13.055.12

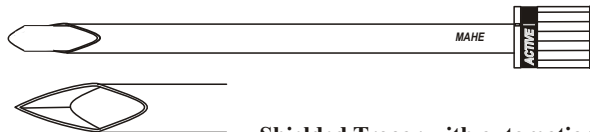

Shielded Trocar with automatic tip cover and lock

Outside-Ø	
5.5 mm	13.060.05
10.5 mm Storz	13.060.10
11.0 mm	13.060.11
12.5 mm	13.060.12

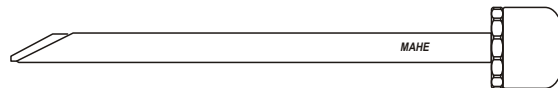

Veress shielded trocar

Outside-Ø	
3.5 mm	13.062.03
5.5 mm	13.062.05
11.0 mm	13.062.11
12.5 mm	13.062.12



Trocar-Systems and Accessories

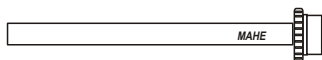

Reducer-sleeve

Outside-Ø	Inside-Ø	
10 mm	- 5 mm	13.070.10
11 mm	- 5 mm	13.070.11
12.5 mm	- 5 mm	13.070.12
12.5 mm	- 10 mm	13.070.13
15 mm	- 5 mm	13.070.15
15 mm	- 10 mm	13.070.16
20 mm	- 15 mm	13.070.20
20 mm	- 10 mm	13.070.21

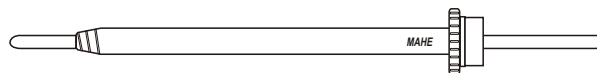

Dilation Set with guide probe

Inside-Ø	Outside-Ø	
5 mm	- 10 mm	13.072.10
5 mm	- 11 mm	13.072.11
10 mm	- 15 mm	13.072.15
10 mm	- 20 mm	13.072.20



Reducer-Adapter

Outside-Ø	Inside-Ø	
11.0 mm	- 5 mm	13.075.11
12.5 mm	- 5 mm	13.075.12



Reducer, short

Outside-Ø	Inside-Ø	
11.0 mm	- 5 mm	13.076.11
12.5 mm	- 5 mm	13.076.12

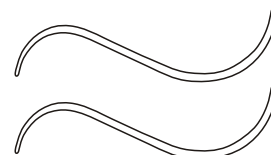

S-retractor, set of 2

5.5 mm	13.080.55
11 mm	13.080.11

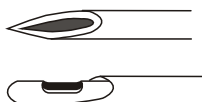
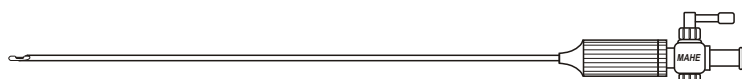

Veress Insufflation-cannula

Working length	Ø 2.0 mm
80 mm	14.002.08
100 mm	14.002.10
120 mm	14.002.12
150 mm	14.002.15
170 mm	14.002.17
200 mm	14.002.20



14.000.00 **Luer Lock End Cap**



14.000.01 **Female Luer Lock Tubing Adapter**



14.000.02 **Male Luer Lock Tubing Adapter**

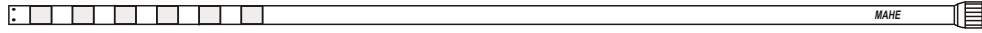

Adaptable Suction-/Irrigation Tubes for 15.001.00 / 15.004.00 / 15.006.00

Outside-Ø	Working Length	
3mm	330mm	15.000.03
5 mm	330 mm	15.000.05
10 mm	330 mm	15.000.10

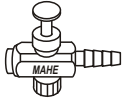

Single Trumpet Valve Handle
15.001.00

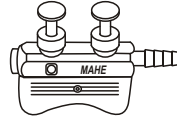

Double Trumpet valve handle with detachable ergonomic handle plate
15.004.00

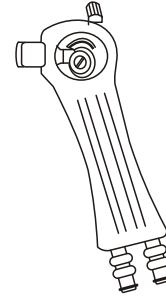

Pistol Handle with maintenance-free 2-way valve
15.006.00

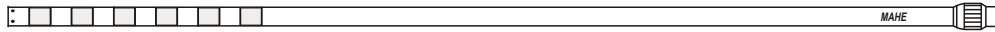

Adaptable Suction-/Irrigation Tube for 15.010.00

Outside-Ø	Working Length	
3mm	330mm	15.010.03
5 mm	330 mm	15.010.05
10 mm	330 mm	15.010.10

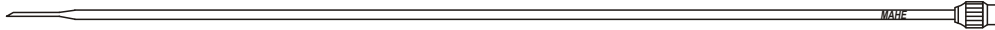

Adaptable Injection-/Puncture Needle for 15.010.00

Outside-Ø	Working Length	
5 mm	330 mm	15.010.50

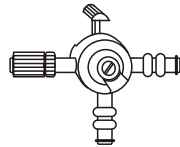

Maintenance-free 2-Way Valve with rotating adapter and LL-connector
15.010.00

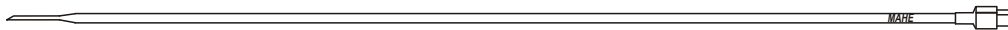

Injection-/Puncture Needle, small LL-connector for syringes

Outside-Ø	Working Length	
3 mm	330 mm	15.011.03
5 mm	330 mm	15.011.33
5 mm	450 mm	15.011.45



Modular Suction-Irrigation System

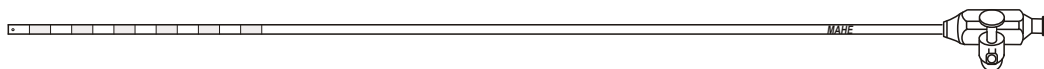

Suction Tube with one lateral trumpet valve, Ø 5 mm, WL 330 mm
15.013.05



Irrigation Channel Insert for 15.013.05
15.013.06

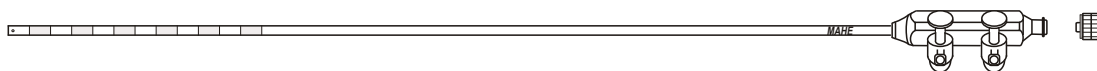

Suction and Irrigation Tube with two lateral trumpet valves, Ø 5 mm, WL 330 mm
15.015.05



Laser Channel Insert for 15.015.05
15.015.06

Bipolar Electrodes, Outside-Ø 3 mm, WL 400 mm, designed for 15.015.05

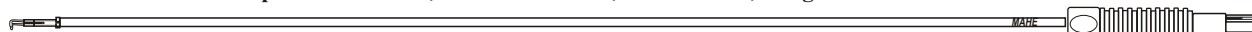

V-Hook Electrode
15.050.01



Right Angle Electrode
15.050.02



10 mm Needle Electrode
15.050.03

Bipolar Electrodes, Outside-Ø 5 mm, WL 340 mm

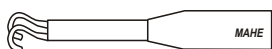
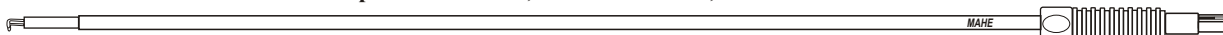

J-Hook Electrode
15.070.01

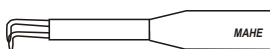

Right Angle Electrode
15.070.02

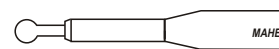

Spatula Electrode
15.070.03



Dome Electrode
15.070.04

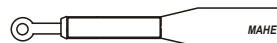
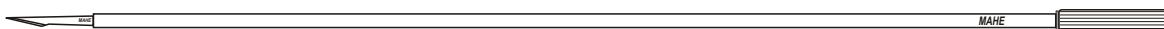

Plate Electrode
15.070.05



Blade Handle, 5 mm, WL 380 mm
15.065.05



Rounded blade
15.020.10



Pointed Blade, straight
15.020.12



Pointed Blade, curved
15.020.14

MAHE International, Inc. 468 Craighead Street Nashville, TN 37204 USA

Website: MahelInternational.com

L-08

1/2005

Toll Free (800) 294-7946 Phone (615) 269-7256 Fax (615) 269-4605 Email info@MahelInternational.com

Monopolar Suction/Irrigation HF Electrodes

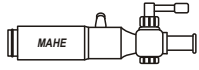

Stop Cock Valve Handle
16.000.01

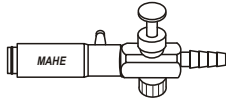

Single Trumpet Valve Handle
16.000.02

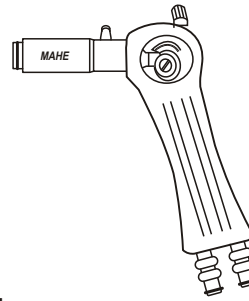

Pistol Handle with maintenance free 2-way valve
16.000.06

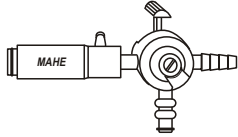

Two Way Valve Handle
16.000.03

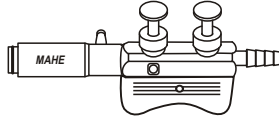

Double Trumpet Valve Handle with Detachable ergonomic handle plate
16.000.05



Adaptable monopolar HF-Electrodes for modular handles of series 16.000.01/16.000.02/16.000.03/16.000.04/16.000.05 and 16.000.06

Ø 5 mm

Adaptable Electrodes



Hook Electrode, thin

Working length

330 mm 16.001.33

450 mm 16.001.45



Hook Electrode, thick

330 mm 16.002.33

450 mm 16.002.45



Right Angle Electrode

330 mm 16.003.33

450 mm 16.003.45



Spatula Electrode

330 mm 16.004.33

450 mm 16.004.45



Ball Point Electrode

330 mm 16.005.33

450 mm 16.005.45



Knife Electrode

330 mm 16.006.33

450 mm 16.006.45



45° Needle Electrode

330 mm 16.007.33

450 mm 16.007.45



Needle Electrode

330 mm 16.008.33

450 mm 16.008.45



Suction-/Irrigation Tube

330 mm 16.009.33

450 mm 16.009.45

MAHE International, Inc. 468 Craighead Street Nashville, TN 37204 USA

Website: MahelInternational.com

Toll Free (800) 294-7946 Phone (615) 269-7256 Fax (615) 269-4605 Email info@MahelInternational.com

L-09

1/2005



Monopolar Suction/Irrigation HF Sliding Electrodes

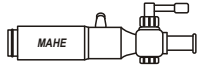

Stop Cock Valve Handle
16.000.01

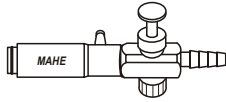

Single Trumpet Valve Handle
16.000.02

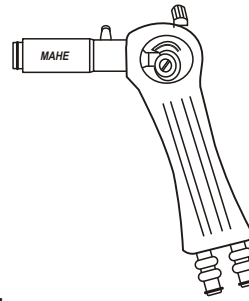

Pistol Handle with maintenance free 2-way valve
16.000.06

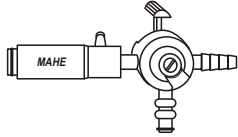

Two Way Valve Handle
16.000.03

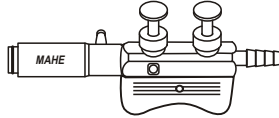

Double Trumpet Valve Handle with Detachable ergonomic handle plate
16.000.05



Adaptable monopolar HF-Electrodes for modular handles of series 16.000.01/16.000.02/16.000.03/16.000.05 and 16.000.06 with sliding insulation



1. Step



2. Step



3. Step

Ø 5 mm



Hook Electrode, thin



Hook Electrode, thick



Right Angle Electrode



Spatula Electrode



Ball Point Electrode



Knife Electrode



45° Needle Electrode



Needle Electrode

Adaptable Electrodes with sliding insulation

Working length

330 mm	16.011.33
450 mm	16.011.45

330 mm	16.012.33
450 mm	16.012.45

330 mm	16.013.33
450 mm	16.013.45

330 mm	16.014.33
450 mm	16.014.45

330 mm	16.015.33
450 mm	16.015.45

330 mm	16.016.33
450 mm	16.016.45

330 mm	16.017.33
450 mm	16.017.45

330 mm	16.018.33
450 mm	16.018.45



Monopolar Electrodes with HF-connector

Ø 5 mm



Hook Electrode, thin



Hook Electrode, thick



Right Angle Electrode



Spatula Electrode



Ball Point Electrode



Knife Electrode



45° Needle Electrode



Needle Electrode

Electrodes with HF-connector

Working length

330 mm	16.021.33
450 mm	16.021.45

330 mm	16.022.33
450 mm	16.022.45

330 mm	16.023.33
450 mm	16.023.45

330 mm	16.024.33
450 mm	16.024.45

330 mm	16.025.33
450 mm	16.025.45

330 mm	16.026.33
450 mm	16.026.45

330 mm	16.027.33
450 mm	16.027.45

330 mm	16.028.33
450 mm	16.028.45



Guillotine Electrode, monopolar, 5/330 mm
16.070.33

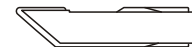

**Standard instruments-connector
for male monopolar 4 mm connector**

Martin, Berchtold, Erbe Generators

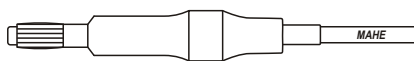

Banana HF Cord

Length	
3000 mm	16.100.00

Bovie ESU's Generator

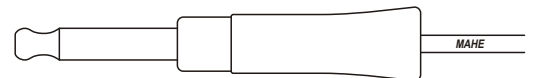

Bovie HF Cord

Length	
3000 mm	16.100.20



Accessories

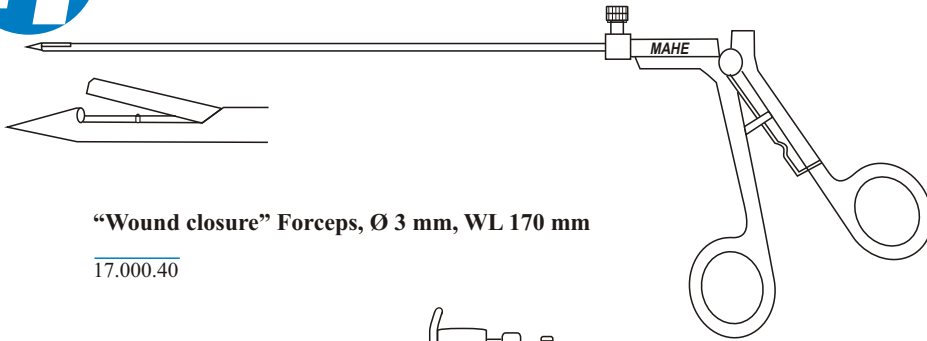

“Wound closure” Forceps, Ø 3 mm, WL 170 mm

17.000.40

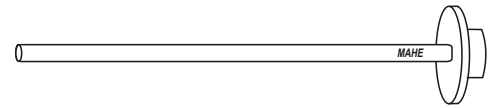

Endo-Ligature Applicator

17.000.20



**Verres Needle “Wound closure”
Ø 2 mm, WL 150 mm**

17.000.60



Hook Needle “Wound closure”

17.000.80

Knot pusher, Ø 5 mm

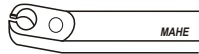

with & without suture opening

Working Length
330 mm 17.001.33
450 mm 17.001.45

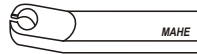

with suture opening

Working Length
330 mm 17.002.33
450 mm 17.002.45

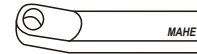

without suture opening

Working Length
330 mm 17.003.33
450 mm 17.003.45

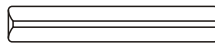
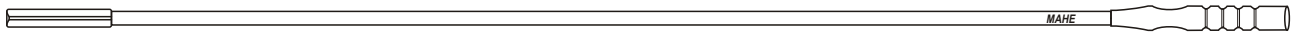

Knot pusher, Ø 5 mm, with slide opening

330 mm 17.004.33
450 mm 17.004.45



Palpation Probe Ø 5 mm, graduated

Working Length
330 mm 17.005.33
450 mm 17.005.45

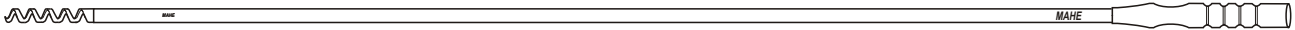

Myoma Screw Ø 5 mm

Working Length
330 mm 17.020.33
450 mm 17.020.45



Myoma Screw Ø 10 mm

Working Length
330 mm 17.025.33
450 mm 17.025.45



Myoma Fixation Screw Ø 5 mm

Working Length
330 mm 17.030.33
450 mm 17.030.45



Myoma Fixation Screw Ø 10 mm

Working Length
330 mm 17.035.33
450 mm 17.035.45

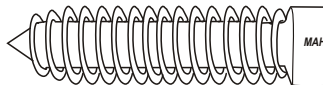

MAHE International, Inc. 468 Craighead Street Nashville, TN 37204 USA

Website: MahelInternational.com

Accessories

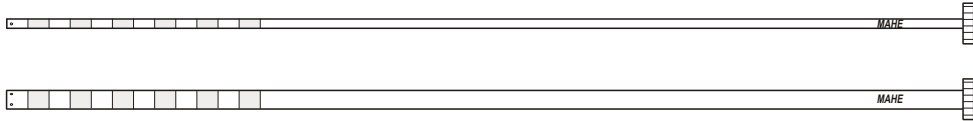

Endo Suction-/Irrigation tubes, WL 330 mm,for 17.050.00

Ø 5 mm 17.050.05
Ø 10 mm 17.050.10

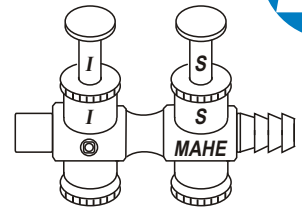

Endo-Suction-/Irrigation handle
17.050.00

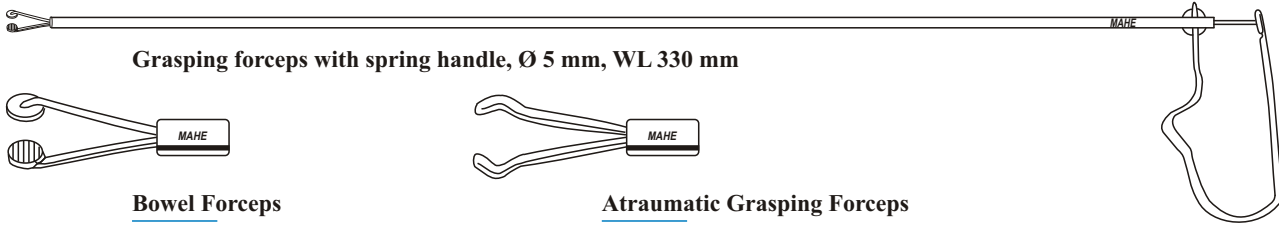

Grasping forceps with spring handle, Ø 5 mm, WL 330 mm

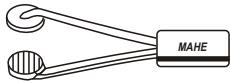

Bowel Forceps
17.070.33



Atraumatic Grasping Forceps
17.071.33

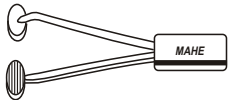

T-Pattern Forceps
17.072.33

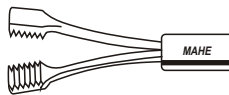

Square-Pattern Forceps
17.073.33

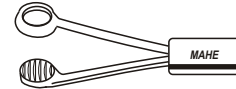

Ring-Pattern Forceps
17.074.33

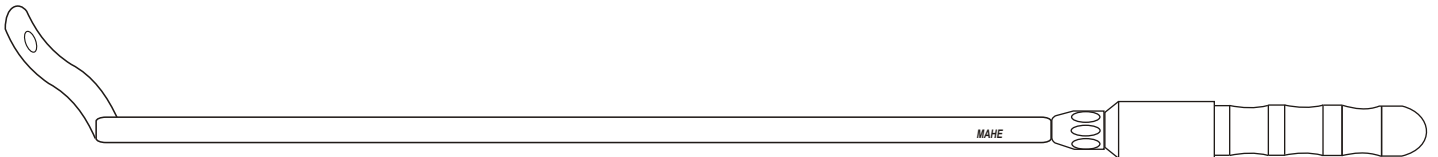

Lap Band Retractor, articulating, 5 mm

33 cm 17.100.33
45mm 17.100.45

Lap Band Retractor, articulating, 10 mm

33 cm 17.102.33
45mm 17.102.45

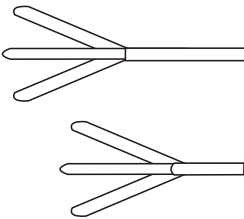

**Straight Fan Retractor,
Ø 5 mm, WL 340 mm**
17.113.33

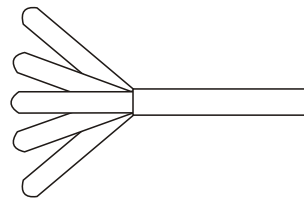

**Straight Fan Retractor,
Ø 10 mm, WL 380 mm**
17.114.33

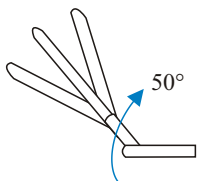
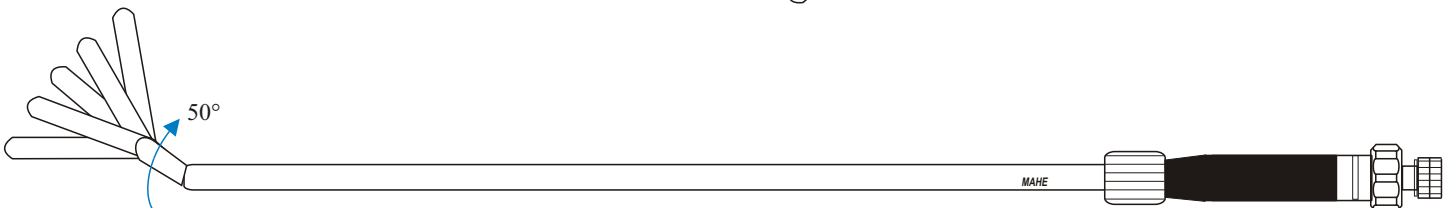

**50° Adjustable Fan Retractor,
Ø 5 mm, WL 340 mm**
17.115.33

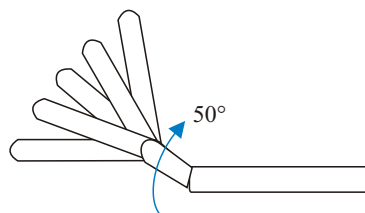

**50° Adjustable Fan Retractor,
Ø 10 mm, WL 380 mm**
17.116.33

MAHE International, Inc. 468 Craighead Street Nashville, TN 37204 USA

Website: MahelInternational.com

Toll Free (800) 294-7946 Phone (615) 269-7256 Fax (615) 269-4605 Email info@MahelInternational.com



Accessories

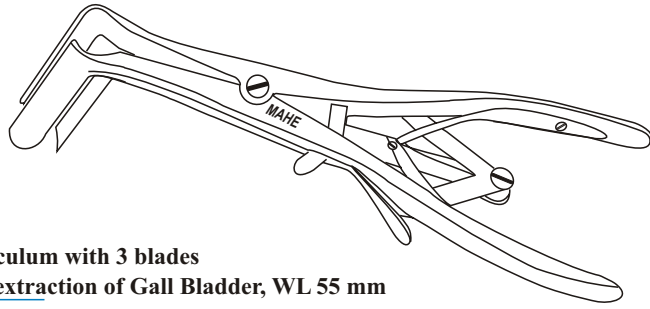

**Speculum with 3 blades
for extraction of Gall Bladder, WL 55 mm**
17.120.00



**Cholangiography Probe,
radiolucent, WL 330 mm**
Ø 11.0 mm 17.150.11
Ø 12.5 mm 17.150.12

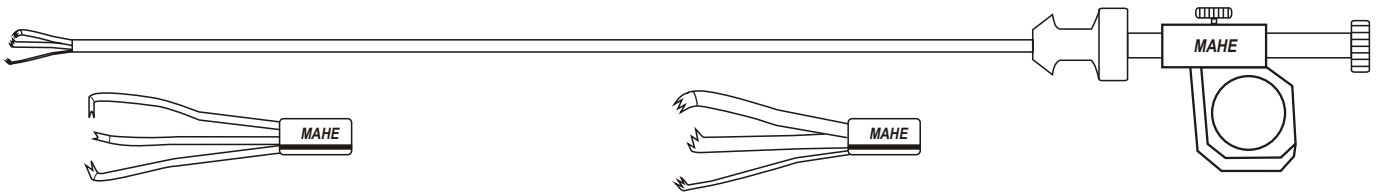

Aggressive 3 Prong Grasper, 5 mm, WL 330 mm
17.160.33

Allis 3 Prong Grasper, 5 mm, WL 330 mm
17.161.33

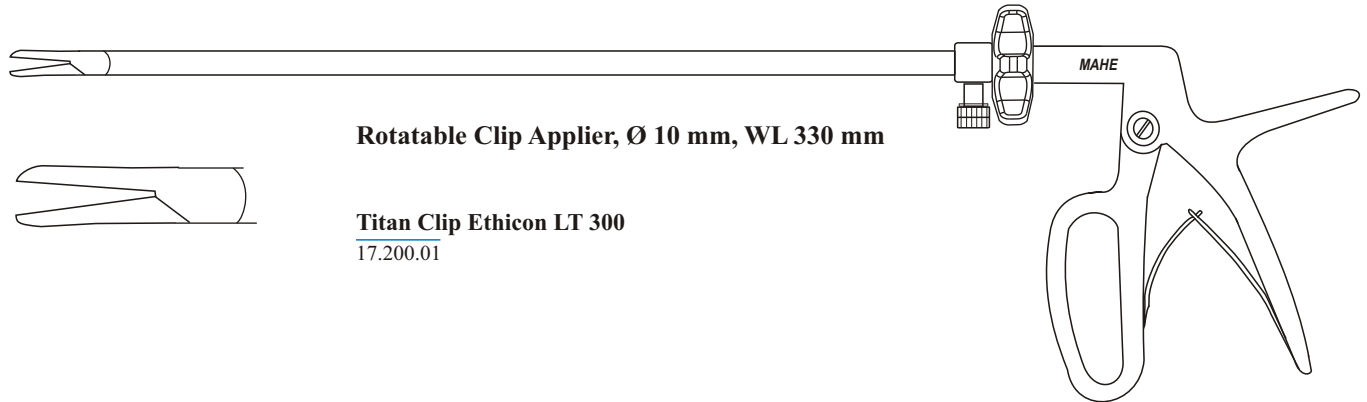

Rotatable Clip Applier, Ø 10 mm, WL 330 mm

Titan Clip Ethicon LT 300
17.200.01

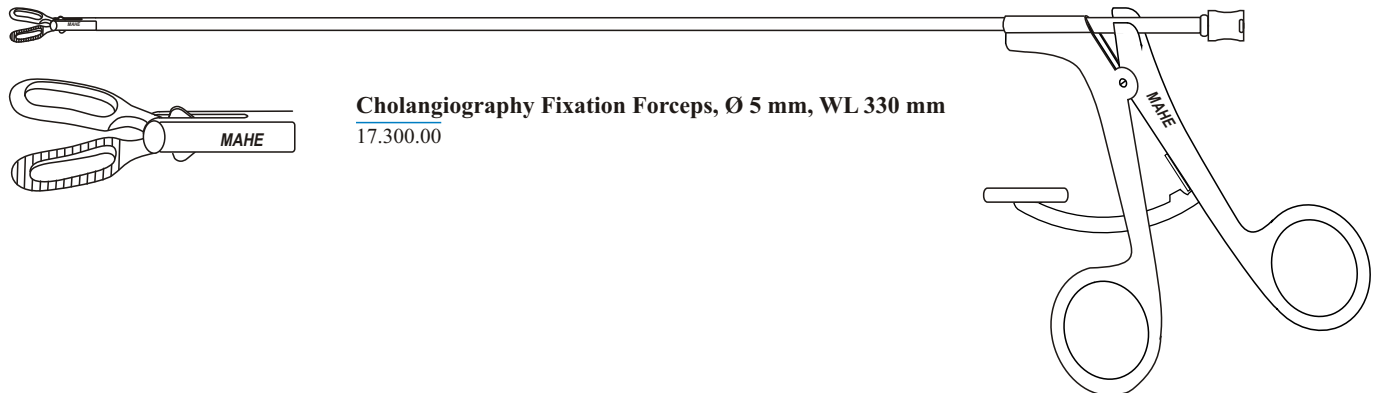

Cholangiography Fixation Forceps, Ø 5 mm, WL 330 mm
17.300.00

Bipolar Forceps 5 mm, rigid, with cleaning port

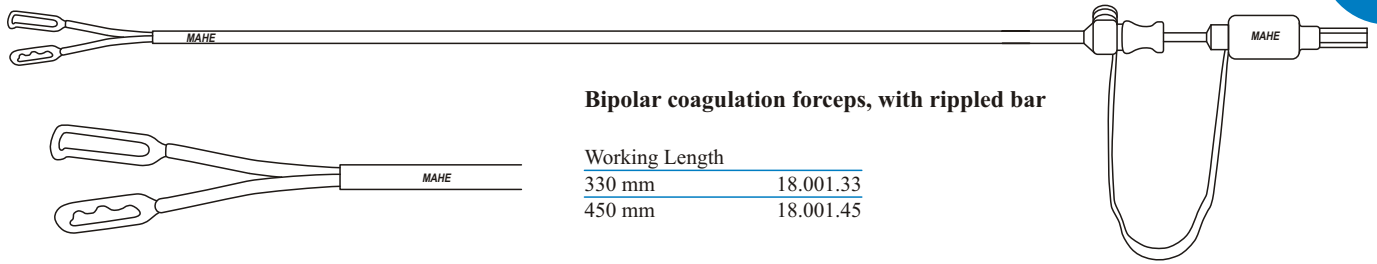

Bipolar coagulation forceps, with rippled bar

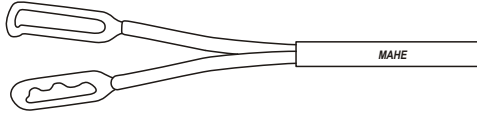

Working Length	
330 mm	18.001.33
450 mm	18.001.45

Bipolar Coagulation forceps, 3 mm jaw

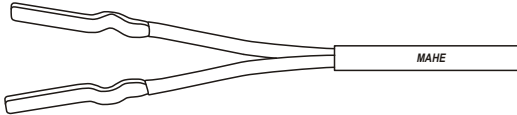

Working Length	
330 mm	18.003.33
450 mm	18.003.45

Bipolar Coagulation forceps, 1 mm jaw

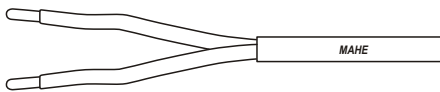

Working Length	
330 mm	18.005.33
450 mm	18.005.45

Bipolar Silicon cables with Universal Flat plug

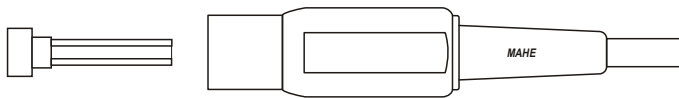

Advantages

- high-quality silicone cable
- smooth surface, easy to clean
- free of Latex

AUTOCLAVE
134° C / 273° F

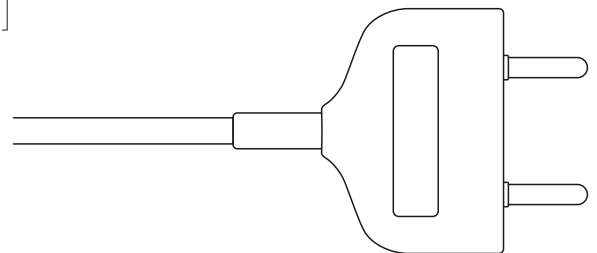
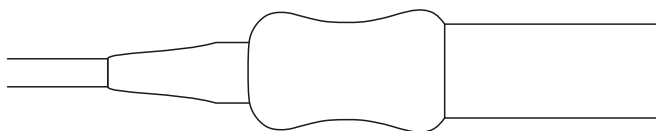
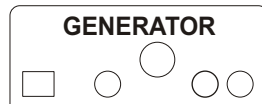

Erbe / Select / Storz

Length	Universal plug
3000 mm	18.900.01
5000 mm	18.900.02

Valleylab

Length	Universal plug
3000 mm	18.900.05
5000 mm	18.900.06

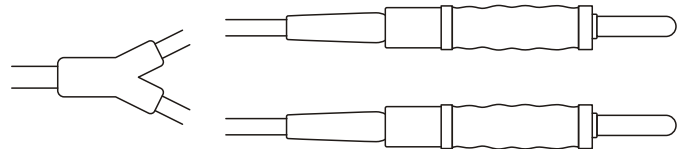
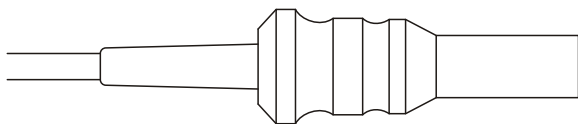

Wolf / Martin / Berchtold / Aesculap

Length	Universal plug
3000 mm	18.900.10
5000 mm	18.900.11

2 Banana plugs

Length	Universal plug
3000 mm	18.900.15
5000 mm	18.900.16

MAHE International, Inc. 468 Craighead Street Nashville, TN 37204 USA

Website: MahelInternational.com

Toll Free (800) 294-7946 Phone (615) 269-7256 Fax (615) 269-4605 Email info@MahelInternational.com



Modular Bipolar Coagulation Forceps, 5 mm

Reusable instrument for use in laparoscopy for grasping and cutting tissue during bipolar

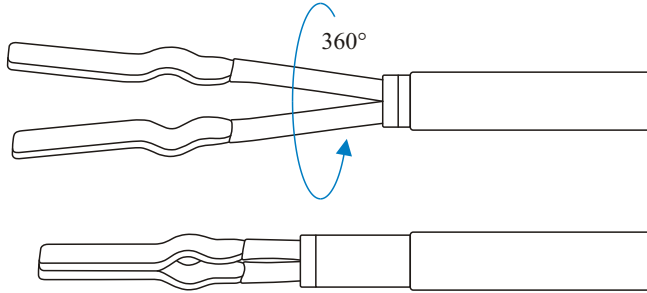

Comfortable Handling

The electrode can be rotated 360° for accurate jaw orientation. There is no receding of the jaw when closing. This allows precise grasping and coagulation of the tissue.

Hygiene and Cost Effectiveness

The forceps are easily detachable. This allows to reliably clean even highly unaccessible areas. Because of its modular design, all parts are interchangeable and therefore easy to repair. The various electrodes can be all used in the same, ergonomically designed handle.

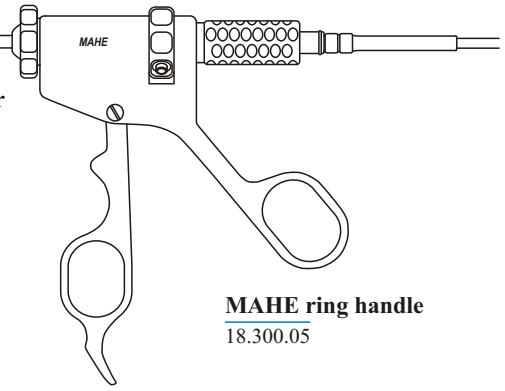

MAHE ring handle
18.300.05

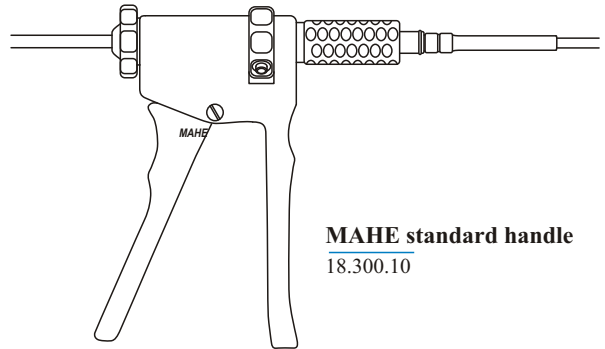

MAHE standard handle
18.300.10

Outer tube

Working length	
200 mm	18.305.20
340 mm	18.305.34
450 mm	18.305.45

Inner tube

Working length	
200 mm	18.306.20
340 mm	18.306.34
450 mm	18.306.45

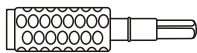
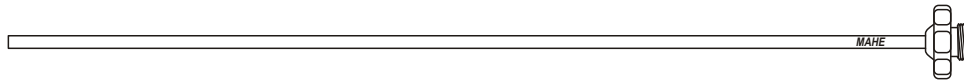

Adapter with flat plug
18.310.01

Compatibility

The forceps in conjunction with the respective connection cable is compatible with the bipolar output of most electro-surgical generators not exceeding 60 Watts. An adapter can be used in order to connect a standard bipolar forceps cable.

Bipolar Silicon cables with rotatable plug

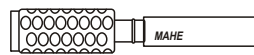

AUTOCLAVE
134° C / 273° F

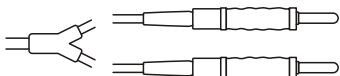

2 Banana Plugs

Length	Rotatable plug
3000 mm	18.403.01

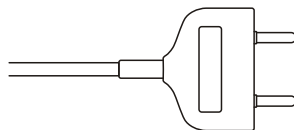

Valleylab

Length	Rotatable plug
3000 mm	18.403.05

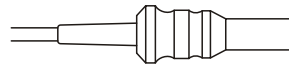

Wolf / Martin / Berchtold / Aesculap Erbe / Select / Storz

Length	Rotatable plug
3000 mm	18.403.10



Length	Rotatable plug
3000 mm	18.403.15

MAHE International, Inc. 468 Craighead Street Nashville, TN 37204 USA

L-16

Website: MahelInternational.com

1/2005

Toll Free (800) 294-7946 Phone (615) 269-7256 Fax (615) 269-4605 Email info@MahelInternational.com

Modular Bipolar Coagulation Forceps, 5 mm

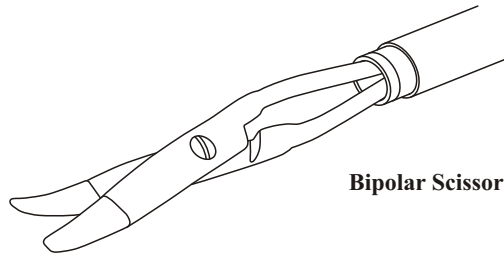

Bipolar Scissors

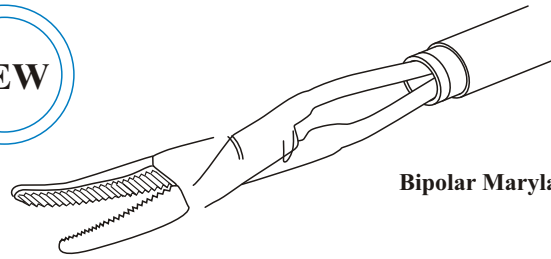

Bipolar Maryland

Complete instrument

Insert only

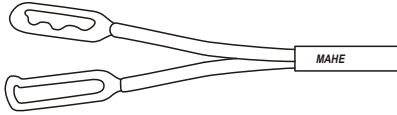

Bipolar forceps with rippled bar

With MAHE ring handle

200 mm	18.100.20
250 mm	18.100.25
340 mm	18.100.34
450 mm	18.100.45

Insert with rippled bar

Working length

200 mm	18.200.20
250 mm	18.200.25
340 mm	18.200.34
450 mm	18.200.45

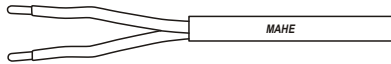

Fine bipolar forceps, 1 mm jaw

With MAHE ring handle

200 mm	18.102.20
250 mm	18.102.25
340 mm	18.102.34
450 mm	18.102.45

Insert with 1 mm jaw

Working length

200 mm	18.202.20
250 mm	18.202.25
340 mm	18.202.34
450 mm	18.202.45

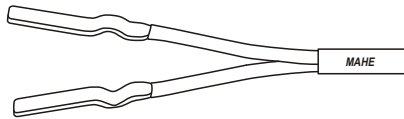

Bipolar forceps, 3 mm jaw

With MAHE ring handle

200 mm	18.104.20
250 mm	18.104.25
340 mm	18.104.34
450 mm	18.104.45

Insert with 3 mm jaw

Working length

200 mm	18.204.20
250 mm	18.204.25
340 mm	18.204.34
450 mm	18.204.45

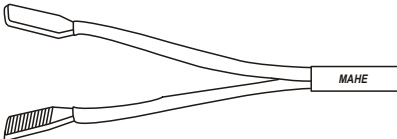

Bipolar grasping forceps, serrated jaw

With MAHE ring handle

200 mm	18.106.20
250 mm	18.106.25
340 mm	18.106.34
450 mm	18.106.45

Insert with serrated jaw

Working length

200 mm	18.206.20
250 mm	18.206.25
340 mm	18.206.34
450 mm	18.206.45



Bipolar scissors, curved

With MAHE ring handle

200 mm	18.108.20
250 mm	18.108.25
340 mm	18.108.34
450 mm	18.108.45

Scissors Insert

Working length

200 mm	18.208.20
250 mm	18.208.25
340 mm	18.208.34
450 mm	18.208.45



Bipolar Maryland, curved

With MAHE ring handle

200 mm	18.110.20
250 mm	18.110.25
340 mm	18.110.34
450 mm	18.110.45

Maryland Insert

Working length

200 mm	18.210.20
250 mm	18.210.25
340 mm	18.210.34
450 mm	18.210.45

MAHE International, Inc. 468 Craighead Street Nashville, TN 37204 USA

Website: MahelInternational.com

Toll Free (800) 294-7946 Phone (615) 269-7256 Fax (615) 269-4605 Email info@MahelInternational.com

L-17

1/2005



Modular Instrument Handles -rotatable-/detachable

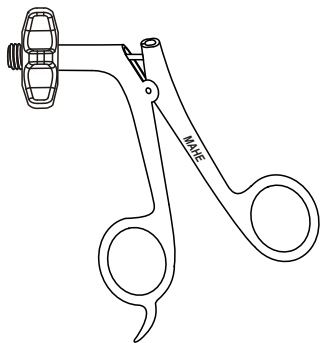

Metal handle
19.20

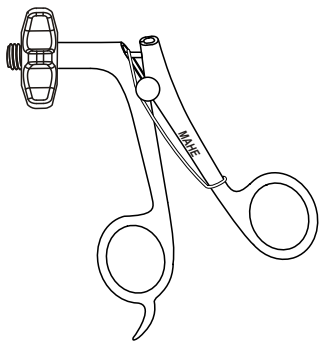

Metal handle with spring
19.21

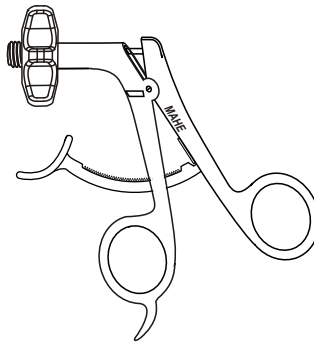

Metal handle with front ratchet
19.22



Insulated metal handle with HF-connector
19.26



Carbon handle, Without HF-connector
19.200

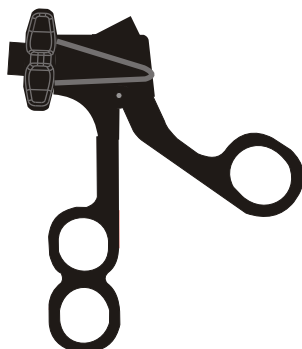

Carbon handle, with spring, without HF-connector
19.210

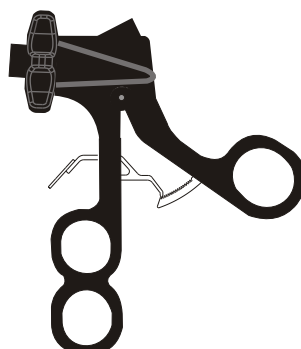

Carbon handle, with ratchet, Without HF-connector
19.220

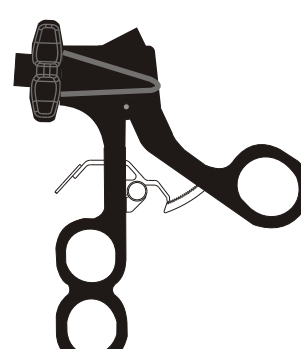

Carbon handle, with activating-deactivating ratchet, without HF-connector
19.230

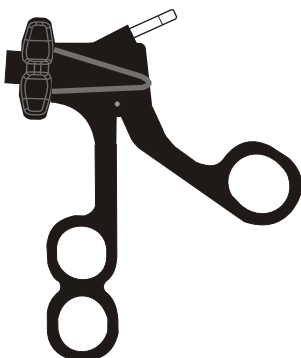

Carbon handle, With HF-connector
19.240

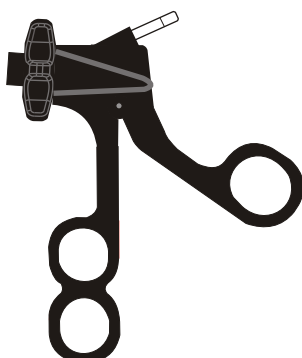

Carbon handle, with spring, with HF-connector
19.250

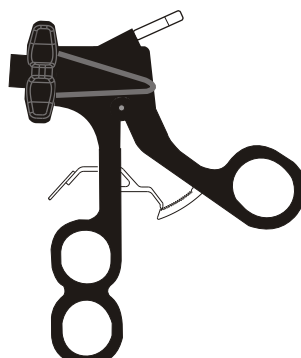

Carbon handle, with ratchet, with HF-connector
19.260

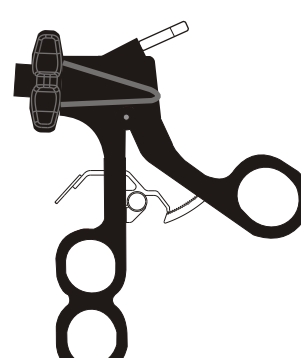

Carbon handle, with activating-Deactivating ratchet, with HF-connector
19.270

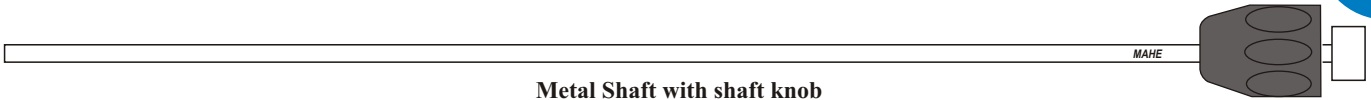

Metal Shaft with shaft knob

	Working length 220 mm	Working length 330 mm	Working length 450 mm
Ø 5 mm	19.50/22	19.50/33	19.50/45
Ø 10-5 mm	19.51/22	19.51/33	19.51/45
Ø 10 mm	19.52/22	19.52/33	19.52/45

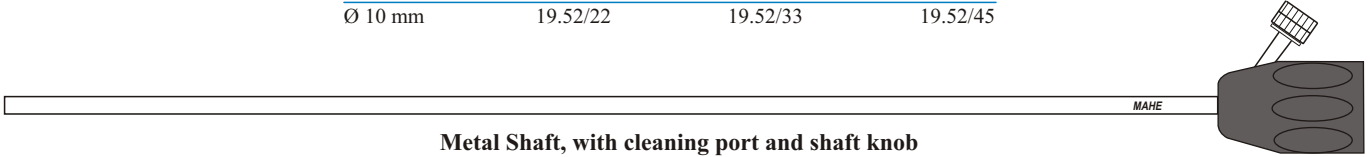

Metal Shaft, with cleaning port and shaft knob

	Working length 220 mm	Working length 330 mm	Working length 450 mm
Ø 5 mm	19.55/22	19.55/33	19.55/45
Ø 10-5 mm	19.56/22	19.56/33	19.56/45
Ø 10 mm	19.57/22	19.57/33	19.57/45



Insulated Shaft with shaft knob

	Working length 220 mm	Working length 330 mm	Working length 450 mm
Ø 5 mm	19.60/22	19.60/33	19.60/45
Ø 10-5 mm	19.61/22	19.61/33	19.61/45
Ø 10 mm	19.62/22	19.62/33	19.62/45

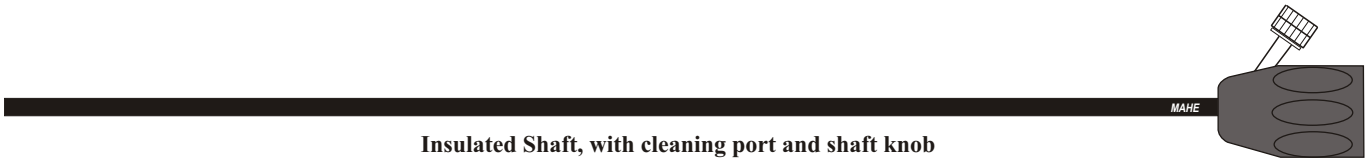

Insulated Shaft, with cleaning port and shaft knob

	Working length 220 mm	Working length 330 mm	Working length 450 mm
Ø 5 mm	19.65/22	19.65/33	19.65/45
Ø 10-5 mm	19.66/22	19.66/33	19.66/45
Ø 10 mm	19.67/22	19.67/33	19.67/45

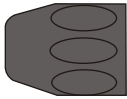

Shaft Knob

Ø 5 mm	19.80/5
Ø 10 mm	19.80/10

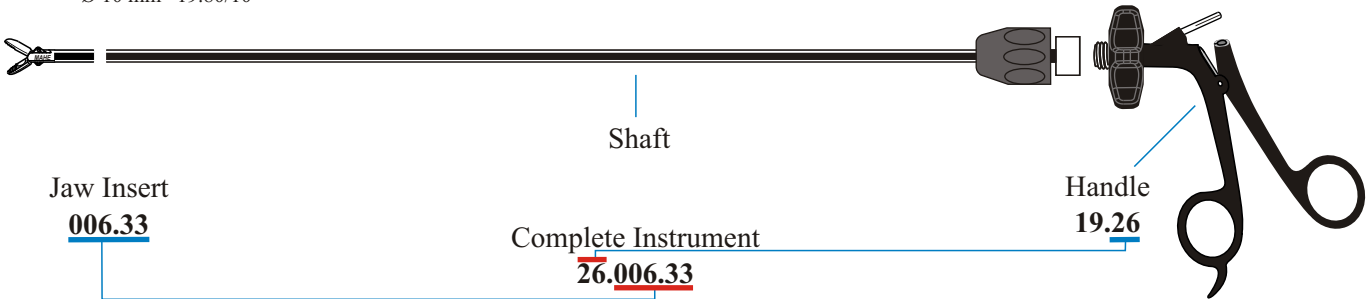

How to Order the Complete Instrument

Start with the last set of the numbers from the handle

Add the part # of the insert as shown above

Add code "R" at the end for non-take apart instruments (example 26.006.33R)

Add code "NC" at the end for non-take apart/ non rotatable instruments (example 26.006.33NC)

MAHE International, Inc. 468 Craighead Street Nashville, TN 37204 USA

Website: MahelInternational.com

Toll Free (800) 294-7946 Phone (615) 269-7256 Fax (615) 269-4605 Email info@MahelInternational.com



Modular 5 mm Inserts - Grasping and Dissecting

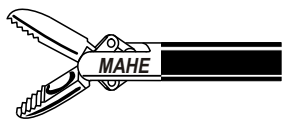

Cone Grasping insert

Working Length	Jaw Insert
220 mm	000.22
330 mm	000.33
450 mm	000.45

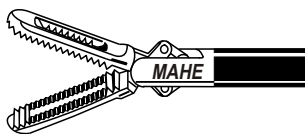

Fenestrated insert

Working Length	Jaw Insert
220 mm	018.22
330 mm	018.33
450 mm	018.45

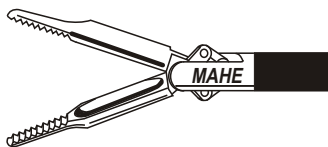

Long Dolphin insert

Working Length	Jaw Insert
220 mm	002.22
330 mm	002.33
450 mm	002.45

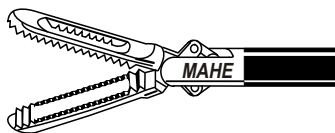

Wide Fenestrated insert

Working Length	Jaw Insert
220 mm	019.22
330 mm	019.33
450 mm	019.45



Short Dolphin insert

Working Length	Jaw Insert
220 mm	004.22
330 mm	004.33
450 mm	004.45



Micro fenestrated insert

Working Length	Jaw Insert
220 mm	020.22
330 mm	020.33
450 mm	020.45



Beak insert with spoon

Working Length	Jaw Insert
220 mm	005.22
330 mm	005.33
450 mm	005.45



Micro insert

Working Length	Jaw Insert
220 mm	022.22
330 mm	022.33
450 mm	022.45



Long Grasping with spoon

Working Length	Jaw Insert
220 mm	006.22
330 mm	006.33
450 mm	006.45



Micro Kelly insert

Working Length	Jaw Insert
220 mm	024.22
330 mm	024.33
450 mm	024.45

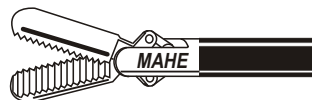

Grasping insert

Working Length	Jaw Insert
220 mm	008.22
330 mm	008.33
450 mm	008.45

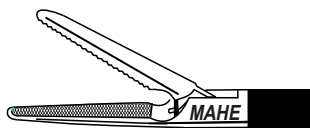

Long atraumatic grasping

Working Length	Jaw Insert
220 mm	026.22
330 mm	026.33
450 mm	026.45

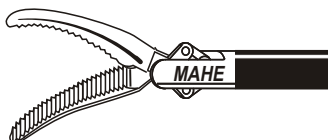

Maryland insert

Working Length	Jaw Insert
220 mm	010.22
330 mm	010.33
450 mm	010.45



Grasping insert, straight

Working Length	Jaw Insert
220 mm	028.22
330 mm	028.33
450 mm	028.45



Kelly insert

Working Length	Jaw Insert
220 mm	012.22
330 mm	012.33
450 mm	012.45



Grasping insert, curved

Working Length	Jaw Insert
220 mm	030.22
330 mm	030.33
450 mm	030.45

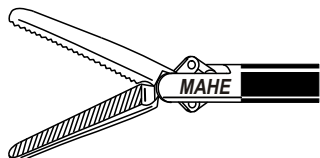

Long atraumatic grasping

Working Length	Jaw Insert
220 mm	014.22
330 mm	014.33
450 mm	014.45



Alligator Grasping insert

Working Length	Jaw Insert
220 mm	032.22
330 mm	032.33
450 mm	032.45

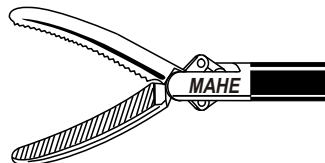

Long atraumatic concave

Working Length	Jaw Insert
220 mm	016.22
330 mm	016.33
450 mm	016.45

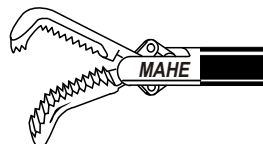

Mixer 60° insert

Working Length	Jaw Insert
220 mm	034.22
330 mm	034.33
450 mm	034.45

MAHE International, Inc. 468 Craighead Street Nashville, TN 37204 USA

L-20

Website: MahelInternational.com

1/2005

Toll Free (800) 294-7946 Phone (615) 269-7256 Fax (615) 269-4605 Email info@MahelInternational.com

Modular 5 mm Inserts - Grasping and Dissecting

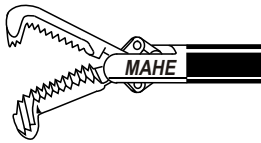

Mixer 90° insert

Working Length	Jaw Insert
220 mm	036.22
330 mm	036.33
450 mm	036.45



Alligator, with spoon

Working Length	Jaw Insert
220 mm	038.22
330 mm	038.33
450 mm	038.45

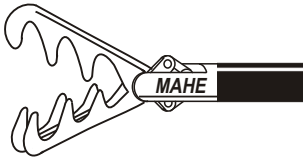

DaVinci insert

Working Length	Jaw Insert
220 mm	040.22
330 mm	040.33
450 mm	040.45

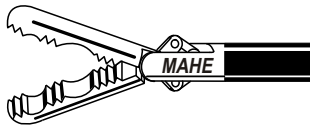

Maxi insert

Working Length	Jaw Insert
220 mm	042.22
330 mm	042.33
450 mm	042.45

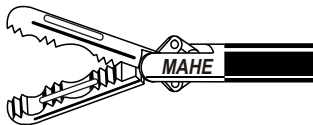

Mc Kearnan insert

Working Length	Jaw Insert
220 mm	043.22
330 mm	043.33
450 mm	043.45

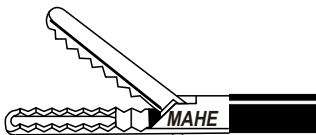

Crocodile, insert single action

Working Length	Jaw Insert
220 mm	044.22
330 mm	044.33
450 mm	044.45

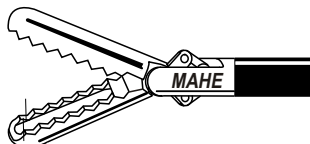

Crocodile, insert double action

Working Length	Jaw Insert
220 mm	045.22
330 mm	045.33
450 mm	045.45

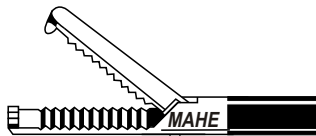

Retraction insert

Working Length	Jaw Insert
220 mm	046.22
330 mm	046.33
450 mm	046.45



Oviduct insert

Working Length	Jaw Insert
220 mm	048.22
330 mm	048.33
450 mm	048.45



Dissecting, fine pattern

Working Length	Jaw Insert
220 mm	050.22
330 mm	050.33
450 mm	050.45

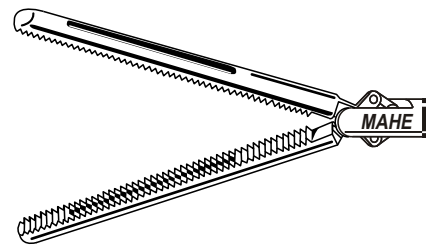

Fenestrated Bowel insert

Working Length	Jaw Insert
220 mm	060.22
330 mm	060.33
450 mm	060.45

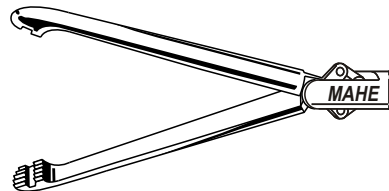

Allis insert

Working Length	Jaw Insert
220 mm	062.22
330 mm	062.33
450 mm	062.45

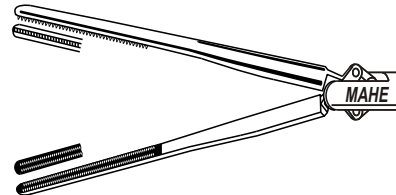

De Bakey insert

Working Length	Jaw Insert
220 mm	064.22
330 mm	064.33
450 mm	064.45

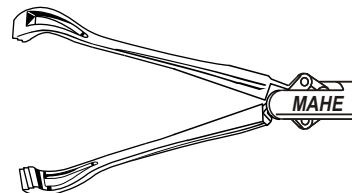

Babcock insert

Working Length	Jaw Insert
220 mm	066.22
330 mm	066.33
450 mm	066.45

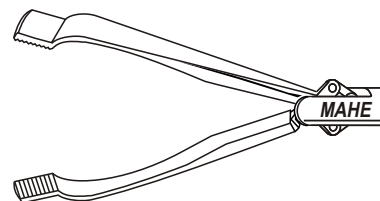

Paddle Babcock insert

Working Length	Jaw Insert
220 mm	068.22
330 mm	068.33
450 mm	068.45

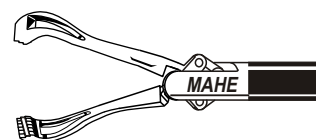

Baby Babcock insert

Working Length	Jaw Insert
220 mm	070.22
330 mm	070.33
450 mm	070.45

MAHE International, Inc. 468 Craighead Street Nashville, TN 37204 USA

Website: MahelInternational.com

Toll Free (800) 294-7946 Phone (615) 269-7256 Fax (615) 269-4605 Email info@MahelInternational.com



Modular 5 mm Inserts - Biopsy and Scissors



Biopsy Spoon, double action

Working Length	Jaw Insert
220 mm	080.22
330 mm	080.33
450 mm	080.45



Micro scissors, straight

Working Length	Jaw Insert
220 mm	200.22
330 mm	200.33
450 mm	200.45



Biopsy Spoon, double action

Working Length	Jaw Insert
220 mm	082.22
330 mm	082.33
450 mm	082.45



Micro scissors, curved

Working Length	Jaw Insert
220 mm	202.22
330 mm	202.33
450 mm	202.45



Biopsy Spoon, single action

Working Length	Jaw Insert
220 mm	084.22
330 mm	084.33
450 mm	084.45



Peritoneal scissors, serrated

Working Length	Jaw Insert
220 mm	204.22
330 mm	204.33
450 mm	204.45



Biopsy Spoon, single action

Working Length	Jaw Insert
220 mm	086.22
330 mm	086.33
450 mm	086.45



Hook scissors

Working Length	Jaw Insert
220 mm	206.22
330 mm	206.33
450 mm	206.45



Blakesley biopsy insert

Working Length	Jaw Insert
220 mm	088.22
330 mm	088.33
450 mm	088.45



Baby-Metzenbaum, curved

Working Length	Jaw Insert
220 mm	208.22
330 mm	208.33
450 mm	208.45



Biopsy punch insert

Working Length	Jaw Insert
220 mm	090.22
330 mm	090.33
450 mm	090.45

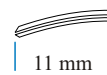

11 mm

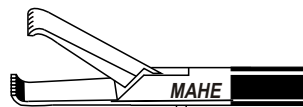

Multiple teeth insert

Working Length	Jaw Insert
220 mm	092.22
330 mm	092.33
450 mm	092.45



Metzenbaum scissors, curved

Working Length	Jaw Insert
220 mm	210.22
330 mm	210.33
450 mm	210.45

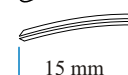

15 mm

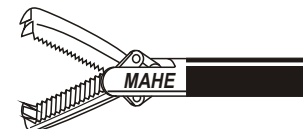

Rat-Tooth insert

Working Length	Jaw Insert
220 mm	094.22
330 mm	094.33
450 mm	094.45



Endo scissors, curved

Working Length	Jaw Insert
220 mm	214.22
330 mm	214.33
450 mm	214.45



14 mm

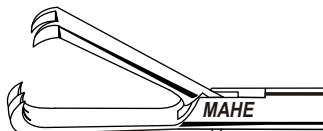

Claw insert

Working Length	Jaw Insert
220 mm	096.22
330 mm	096.33
450 mm	096.45



Metzenbaum scissors, straight, heavy blades pattern

Working Length	Jaw Insert
220 mm	216.22
330 mm	216.33
450 mm	216.45

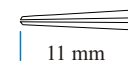

11 mm

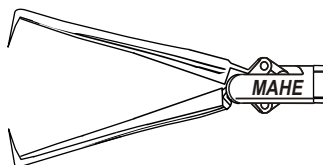

Tenaculum insert

Working Length	Jaw Insert
220 mm	098.22
330 mm	098.33
450 mm	098.45



Metzenbaum scissors, curved, heavy blades pattern

Working Length	Jaw Insert
220 mm	218.22
330 mm	218.33
450 mm	218.45

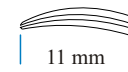

11 mm

MAHE International, Inc. 468 Craighead Street Nashville, TN 37204 USA

Modular 10 mm Inserts - Grasping and Dissecting



10 mm Maryland insert
For 5-10 mm shaft 19.61/XX

Working Length	Jaw Insert
220 mm	110.22
330 mm	110.33
450 mm	110.45



5 mm Alligator insert
For 5-10 mm shaft 19.61/XX

Working Length	Jaw Insert
220 mm	032.22
330 mm	032.33
450 mm	032.45

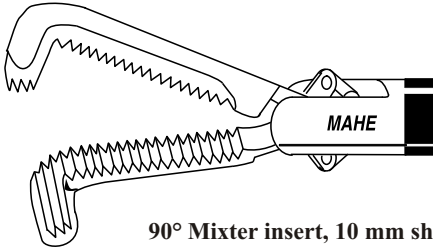

90° Mixer insert, 10 mm shaft

Working Length	Jaw Insert
220 mm	150.22
330 mm	150.33
450 mm	150.45

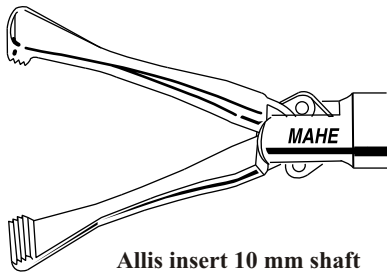

Allis insert 10 mm shaft

Working Length	Jaw Insert
220 mm	152.22
330 mm	152.33
450 mm	152.45

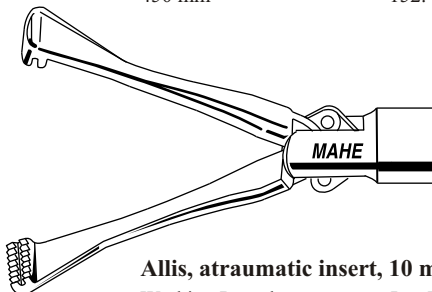

Allis, atraumatic insert, 10 mm shaft

Working Length	Jaw Insert
220 mm	154.22
330 mm	154.33
450 mm	154.45

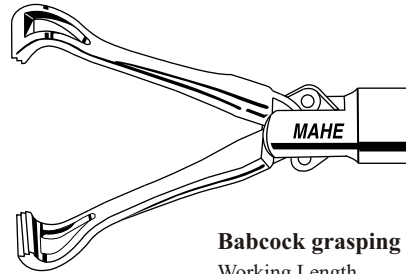

Babcock grasping forceps, 10 mm shaft

Working Length	Jaw Insert
220 mm	156.22
330 mm	156.33
450 mm	156.45

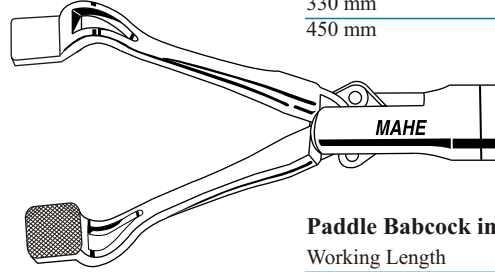

Paddle Babcock insert, 10 mm shaft

Working Length	Jaw Insert
220 mm	157.22
330 mm	157.33
450 mm	157.45

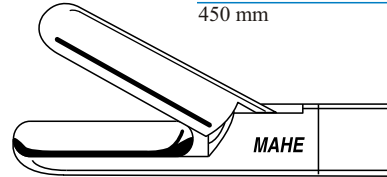

Spoon insert, single action, 10 mm shaft

Working Length	Jaw Insert
220 mm	170.22
330 mm	170.33
450 mm	170.45

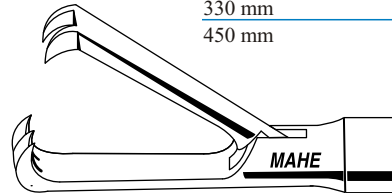

Claw insert, single action, 10 mm shaft

Working Length	Jaw Insert
220 mm	172.22
330 mm	172.33
450 mm	172.45

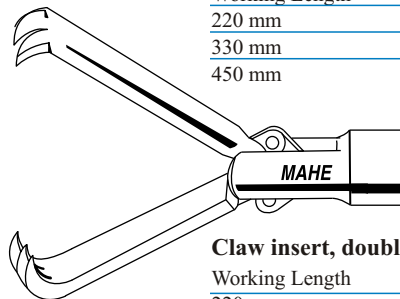

Claw insert, double action, 10 mm shaft

Working Length	Jaw Insert
220 mm	174.22
330 mm	174.33
450 mm	174.45

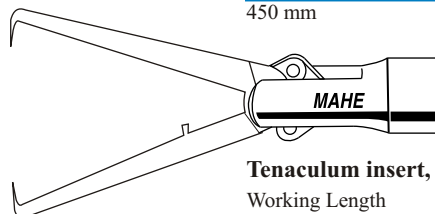

Tenaculum insert, 10 mm shaft

Working Length	Jaw Insert
220 mm	176.22
330 mm	176.33
450 mm	176.45

MAHE International, Inc. 468 Craighead Street Nashville, TN 37204 USA

Website: MahelInternational.com

Toll Free (800) 294-7946 Phone (615) 269-7256 Fax (615) 269-4605 Email info@MahelInternational.com



Needle Holders

Metal Handle with Spring and Cleaning Port, not rotating, not detachable

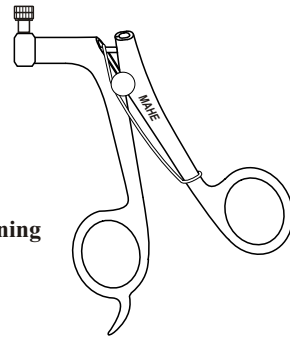

Tungsten Carbide, 3 mm

Working Length	
220 mm	21.240.22
330 mm	21.240.33
450 mm	21.240.45

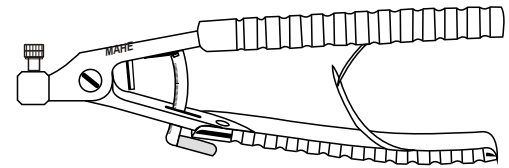

Axial Handle with ratchet and Cleaning Port, not rotating, not detachable

Tungsten Carbide, 3 mm

Working Length	
220 mm	25.240.22
330 mm	25.240.33
450 mm	25.240.45



Serrated Jaw, 3 mm

220 mm	21.242.22
330 mm	21.242.33
450 mm	21.242.45

Serrated Jaw, 3 mm

220 mm	25.242.22
330 mm	25.242.33
450 mm	25.242.45



Tungsten Carbide, 5 mm

220 mm	21.250.22
330 mm	21.250.33
450 mm	21.250.45

Tungsten Carbide, 5 mm

220 mm	25.250.22
330 mm	25.250.33
450 mm	25.250.45



Serrated Jaw, 5 mm

220 mm	21.252.22
330 mm	21.252.33
450 mm	21.252.45

Serrated Jaw, 5 mm

220 mm	25.252.22
330 mm	25.252.33
450 mm	25.252.45



"Flamingo", 5 mm

220 mm	21.260.22
330 mm	21.260.33
450 mm	21.260.45

"Flamingo", 5 mm

220 mm	25.260.22
330 mm	25.260.33
450 mm	25.260.45



"Parrot", 5 mm

220 mm	21.262.22
330 mm	21.262.33
450 mm	21.262.45

"Parrot", 5 mm

220 mm	25.262.22
330 mm	25.262.33
450 mm	25.262.45



Tungsten Carbide, curved left, 5 mm

220 mm	21.264.22
330 mm	21.264.33
450 mm	21.264.45

Tungsten Carbide, curved left, 5 mm

220 mm	25.264.22
330 mm	25.264.33
450 mm	25.264.45



Tungsten Carbide, curved right, 5 mm

220 mm	21.266.22
330 mm	21.266.33
450 mm	21.266.45

Tungsten Carbide, curved right, 5 mm

220 mm	25.266.22
330 mm	25.266.33
450 mm	25.266.45

MAHE International, Inc. 468 Craighead Street Nashville, TN 37204 USA

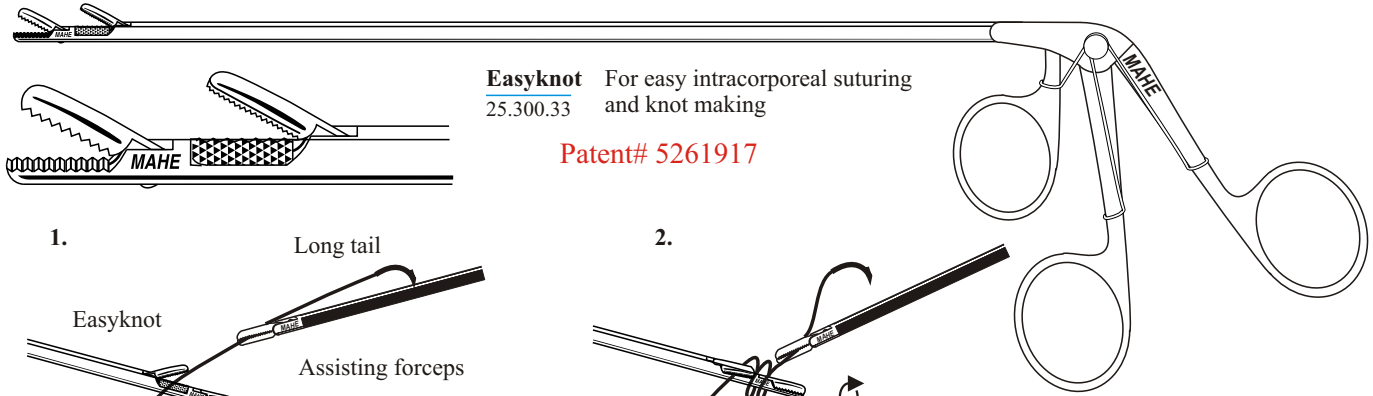

Easyknot For easy intracorporeal suturing
25.300.33 and knot making

Patent# 5261917

1. Long tail

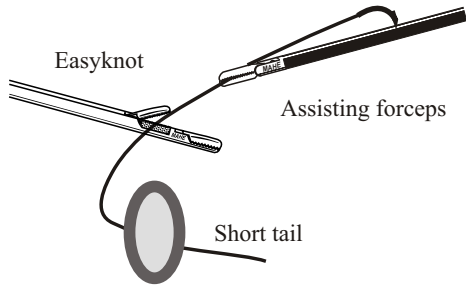

1. Take the stitch with a standard needle holder leaving a 1" - 2" short tail on the needle entry side. Grasp the needle end of the suture with an assisting forceps about 3" - 5" from the operative site to fix the suture. Trap the suture under the upper jaw of the Easyknot device about 1.5" from the point of suture fixation.

2.

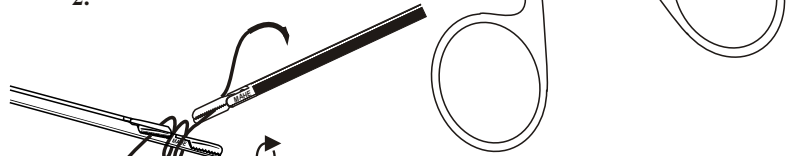

2. Use the assisting forceps to wrap the suture around the Easyknot device twice, distal to the upper jaw (preferably going first under the device than over it).

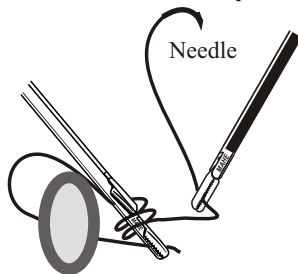

3. Bring both instruments closer to the short tail and hold the tail with the lower jaw of the Easyknot device. Open the upper jaw to release trapped suture and pull the device (holding the suture tail) and assisting forceps (holding the needle suture end) in opposite directions (relative to initial positions) to establish a flat half hitch. Cinch and tighten as needed.

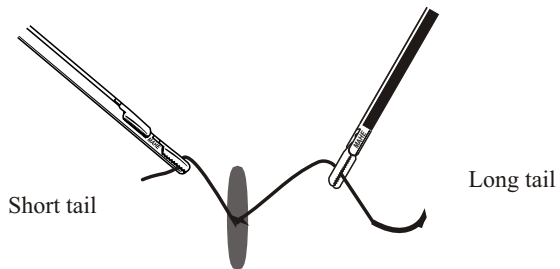

4. Repeat the procedure to form additional half hitches making sure to reverse the direction of pulling on the suture ends to establish a square knot. For instance, if the short end starts on the right side of the incision, it should end at the left side after the first half hitch and again on the right side after the second half hitch.

Developed in cooperation with Drs. Carlos Rotman and Harrith Hasson, Chicago / USA

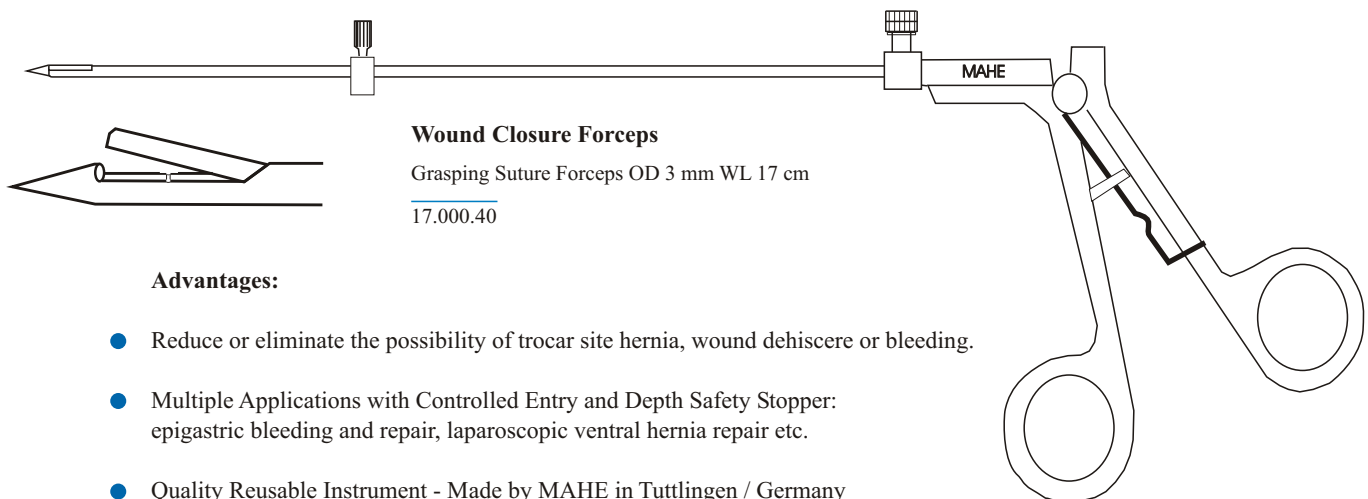

Wound Closure Forceps

Grasping Suture Forceps OD 3 mm WL 17 cm

17.000.40

Advantages:

- Reduce or eliminate the possibility of trocar site hernia, wound dehiscere or bleeding.
- Multiple Applications with Controlled Entry and Depth Safety Stopper: epigastric bleeding and repair, laparoscopic ventral hernia repair etc.
- Quality Reusable Instrument - Made by MAHE in Tuttlingen / Germany
- Easy to Use, especially on obese patients

MAHE International, Inc. 468 Craighead Street Nashville, TN 37204 USA

Website: MahelInternational.com

Toll Free (800) 294-7946 Phone (615) 269-7256 Fax (615) 269-4605 Email info@MahelInternational.com